



**ASIAN-
EUROPEAN
MUSIC
RESEARCH
JOURNAL**



上海音乐学院
SHANGHAI CONSERVATORY OF MUSIC

Vol. 5 (Summer 2020)

λογος

ASIAN-EUROPEAN
MUSIC
RESEARCH JOURNAL

Volume 5
(Summer 2020)

Logos Verlag Berlin



ASIAN-EUROPEAN MUSIC RESEARCH JOURNAL
(AEMR)
Volume 5, (Summer 2020)

Information for subscribers:

ISSN: 2625-378X

DOI: 10.30819/aemr

Subscription Rates/Orders:

*Subscription Rate** 36.00 €

Single Issue 22.00 €

Postage per Issue

- within Germany 2.00 €

- Abroad 4.50 €

* 2 issues, postage not included

see: <https://www.logos-verlag.de/AEMR>

All articles are protected by copyright under the
Creative Commons license CC BY-NC-ND 4.0
(<https://creativecommons.org/licenses/by-nc-nd/4.0>).

All articles are available for free download at
<https://www.logos-verlag.de/AEMR>

Logos Verlag Berlin GmbH
Georg-Knorr-Str. 4, Geb. 10
D-12681 Berlin, Germany
Tel.: +49 (0)30 42 85 10 90
Fax: +49 (0)30 42 85 10 92
INTERNET: <https://www.logos-verlag.de>

AEMR-EJ 5 (SUMMER 2020)

DOI: 10.30819/aemr

CONTENTS

BRIEF INTRODUCTION

ii

ARTICLES AND ESSAYS

Jimenez, Earl Clarence L.

Memories of Sounds: An Archiving Project in Two Aural Communities. 1-8.

Hernandez, Fredyl B.

Musings on the Engagement of the Neophyte with the Established Archive. 9-16.

Thieberger, Nick

Technology in Support of Languages of The Pacific: Neo-Colonial or Post-Colonial? 17-24.

Musib, Ahmad Faudzi

Extracting Audio Signals from 4-Track Analogue Tape and Digital Standalone Multitrack Machine Material as a Part of Preservation. 25-38.

Jähnichen, Gisa

Safeguarding Strategies of Sound Archives and its Meaning to the Pacific Region. 39-43.

Correa, Juan Sebastian

Examining Unintentionality and Intentionality of Sound in Prehistoric Malta. 44-50.

Korum, Solveig

The Sound of Reconciliation? Musical and sociocultural harmony in the Sri Lanka Norway Music Cooperation (2009-2018). 51-65.

Lin Zhi [林芝]

Ways of Singing in Napo County (Guangxi Zhuang Autonomous Region) and in Funing County (Yunnan Province). 66-72.

Long Fei [陇菲]

The Sistrum and the Stick Rattles Sabayi and Sachi. 73-91.

REVIEWS

Lewy, Matthias

Some Thoughts about Professional Fields of Ethnomusicologists in Museums. 92-95.

Jähnichen, Gisa

Review of The Musician and His Art: Essays on Hindustānī Music by Deepak S. Raja. 96-98.

Nguyễn Thế Truyền

Review about the Current Situation of H'rê People's Music at Different Locations in Quảng Ngãi Province, Vietnam. 99-108.

AEMR & EDITORIAL BOARD

109.

CALL FOR SUBMISSION

110.

CoE

111-112.

BRIEF INTRODUCTION

The Number 5 of AEMR-EJ is as diverse as all the previous issues. We offer five papers, written by Jimenez, Hernandez, Musib, and Jähnichen, that emerged from an international workshop about *Safeguarding Strategies of Sound Archives in the Pacific Region* held in Shanghai, November 2019, which extended the scope of regional boundaries regarding an important matter of dealing with the history and future of performing arts. The papers following these first five papers deal with various aspects of sound, either as part of historical artifacts (Correa), social movements (Korum), vocal expressions (Lin Zhi), or as instrumental meanings (Long Fei).

In the review section, there are three other contributions. One is about the role of ethnomusicologists in ethnographic museums (Lewy), followed by a review of a quite recent publication in the Indian research tradition (Jähnichen), and an overview about local music research in the Vietnamese Province Quảng Ngãi (Nguyễn Thế Truyên).

From now onwards, AEMR-EJ, will also be distributed as printed issue, published by LOGOS Berlin. Earlier editions are only available online. In case you need a printed version, please, contact the publisher. ISSN Number and layout will not change as well as all other components such as the Editorial Board, the Call for Submissions, and the Code of Ethics.

AEMR Editors, June 2020.



MEMORIES OF SOUNDS: AN ARCHIVING PROJECT IN TWO AURAL COMMUNITIES

Earl Clarence L. Jimenez

PhD, Philippine Women's University; contact: ecljimenez@pwu.edu.ph

Abstract

Documentation, collection, and the storage of music and sound is second nature to the discipline of ethnomusicology. Frances Desmore's iconic photograph (albeit staged) of a gramophone with Blackfoot leader, Mountain Chief in the early 20th century quite accurately depicts a salient feature of the discipline --- the scholar and the local engaged in the recording of music. The technology and the dress have obviously undergone changes but the photograph continues to echo resonantly. As Jaap Kunst has said and quoted by Seeger, "Ethnomusicology could never have grown into an independent science if the gramophone had not been invented. Only then was it possible to record the musical expressions of foreign peoples objectively." (Seeger, 1986: 261).

Keywords

Archiving, Aural community, Sound collection, Ethnomusicology, fieldwork

INTRODUCTION



FIGURE 1: Picture of Frances Desmore with Mountain Chief.¹

Indeed, the discipline has yielded a rich collection of sonic archives all over the world from the legendary Smithsonian recordings to valuable university collections and, of course, the treasured personal collections of scholars. Perhaps, the difference today is that scholars are more cognizant of the impact of one's strategic location and formation, to use the words of Said (2014), with the subjects being studied and the sound and music being collected. Thus, one's exertions in the collection and archiving of sounds are mediated by the scholar's own authority and power over the materials and the meanings these acquire as he configures and analyse these as social and cultural texts.

¹ <https://www.britannica.com/biography/Frances-Densmore> (public domain, last accessed 6 January, 2020).

My recent work on soundscapes following R. Murray Schafer (1993) and further elaborated by Steven Feld (2015) with the concept of acoustemology has led me to re-examine how I perceive sound archiving. Acoustemology offers an epistemology where sound is a way of knowing. It examines how people engage with the soundscape. Reflecting on these drew me to scrutinize how the collection and storage of sounds as archival material is mediated by the collector's and the performers' engagement with the process of archiving. Archives after all, are not static speechless objects. Following Foucault, they are socially constructed by the collector and the collected allowing numerous possibilities of what can and cannot be collected (Foucault, 1972). Thus, to archive is to peer into people's configuration of their own culture and practices. Reflexively, archiving affords the opportunity for me to postulate on how to organize, present, and manage the collections and the archives.

I bring these concepts into my work with the sound archives of two disparate communities, the Tboli of Lake Sebu in the southern Philippines, and a religious community in the suburbs of Metro Manila. I refer to these two as aural communities as sound is an inherent part of the lives of the people both individually and communally. These are reflected in particular practices such as in ceremonies and rituals where sound plays important roles. I examine how the process of setting-up the archives and engaging the people to document their own sonic practices allowed them to confront issues of heritage and sustainability, to engage in conversation with themselves as they configure aspects of their culture, and to understand how the process of collection and archiving can be a means to empower themselves. I consider archiving in both the communal and individual levels. Current technologies such as built-in recording features in mobile phones, after all, have allowed individuals to make their own recordings and store them as personal collections to be used in the future for whatever purpose they may serve.

THE TBOLI OF LAKE SEBU

The Tboli are an indigenous group living in communities in the Allah Valley in the mountains of southern Philippines. Their cultural heartland is Lake Sebu. My archival work with the Tboli of Lake Sebu began in 2019 as a way of giving back to the community. During fieldwork for the past several years, many locals I came across with have bemoaned how they were often the subject of research by outsiders who do not make any effort to make return visits to the community nor give copies of their research outputs once they are done I sought to address this gap by proposing to conduct workshops for the community on how to document their own sonic culture with the eventual goal of establishing an archive at the School of Living Traditions run by Maria Todi, a respected cultural worker and traditional dancer.

I also noticed that many culture bearers make mention of analog and digital recordings in which they have been featured. These run the gamut from informal recordings made by tourists for social media uploading to recordings by researchers, and to a few compact discs that have been made by a few record labels.

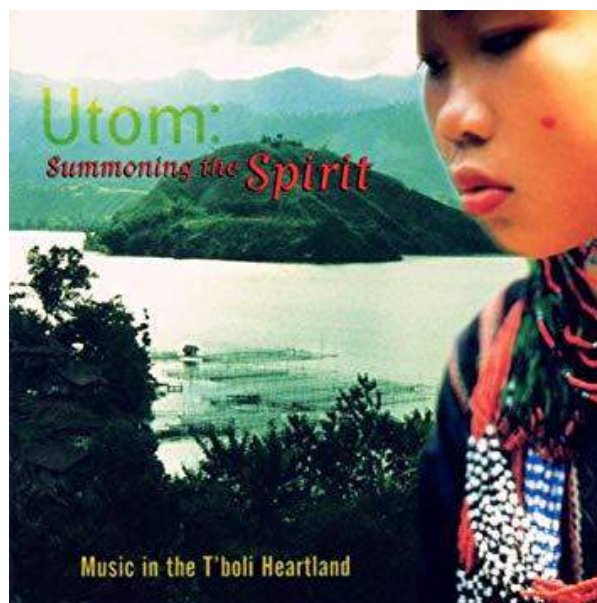

FIGURE 2: The cover of *Utom: Summoning the Spirit* produced by ethnomusicologist, Manolote Mora, featuring his 1995 field recordings.²

Reminiscences by the T'boli of these recordings are almost always accompanied by nostalgia for the music they no longer hear today. In the case of the performers, their nostalgia is directed towards those years when they were actively performing. T'boli artists who have attained legendary status owing to their exemplary musical talents and whose voices and instrument playing they hear on the recordings are likewise remembered often with much awe and admiration. Seeing how these have become part of the memory of the community, in a way framing how they remember certain things, I brought a few of these recordings for them to listen to. One afternoon, while listening to *Tudbulul Lunay Mugul*³, a compact disc of the great chanter, Medung Sabal, Joel Genlal, a highly regarded T'boli drummer, recounted her powerful presence each time she would sing. It was a presence that he felt while listening to her plaintive voice talking about the adventures of the mythical hero, Tudbulul. Listening sessions like this inevitably led to talk on the need for recordings to be made by the T'boli themselves and for themselves. For the past years, the T'boli have been increasingly cognizant of their cultural capital and how they are seemingly left behind as researchers partake of these. It was decided that the time had come to take matters into their own hands; hence, Rosie Sula, a T'boli chanter, made arrangements with me to record her songs as she felt her advancing age may eventually lead her to forget these.

Quite a few T'boli have been documenting their own culture. Maria, herself, has her own collection of recordings when she was working as research assistant to the French anthropologist, Nicole Revel, who was then doing work on epic chants. Her nephew, Michael Yambok, a teacher at a public school and a cluster head for southern cultural communities of the National Commission on Culture and the Arts (NCCA) has been actively engaged in cultural mapping through a government grant. Thus, the workshop I developed was meant to supplement the work that people like Maria and Michael have already been doing. To interested T'boli, it would also provide a semblance of formal training.

² Image (public domain) captured from <https://www.amazon.com/Utom-Summoning-Spirit-Music-Heartland/dp/B0000009R8> last accessed on 6 January, 2020.

³ Released in 2008 by TAO Music, a Philippine recording company known for its albums featuring indigenous musicians.

WORKSHOP ON SOUND HERITAGE COLLECTION AND DOCUMENTATION

I conducted the first workshop in May in time for National Heritage Month. About 20 people from Lake Sebu and Tboli town were invited by Michael. It was a mixed crowd of college level students, teachers, and a few cultural workers. The two-day workshop was a combination of short lectures on music heritage, and documentation and collection practices. To get an actual feel of these processes, it also included practical activities such as photographing, drawing, and measuring music instruments, and transcribing song texts. The workshop was contextualized within the current availability of resources in the community. Mobile phones, for example, were used as the primary recording tools as these were widely available. I drew-up a simple 5-step process consisting of the following: Inventory, Assess, Choose, Plan, Collect and Document. This was meant to be a rough guide for the community to follow when they finally work on their own.

In the inventory step, participants identify what they consider as their sound heritage. Expectedly, questions on what they consider as originally theirs as opposed to what is borrowed inevitably make their way into the discussion. The assessment step evaluates: current musical practices, the transmission and continuity efforts of individuals and of the community, and the collection and documentation that have been done, whether by themselves or by outsiders. The step involves an evaluative criteria such as: the presence of acknowledged culture bearers or people adept with the music and the music instruments, if was still being heard by the community, if the present generation was familiar with it, if they knew the practices associated with the music making, and so forth. Participants then choose what they want to collect and document, whether it is based on personal preference or community need. In this step, participants also learn to prioritize especially if a particular musical practice is in danger of disappearing or a singer or instrumentalist is already ailing. Planning involves scheduling visits and recording sessions while at the same time being on the lookout for spontaneous opportunities to capture a sonic event. After all these have been done will participants finally engage in collection and documentation following procedures they learned in the workshop.

The participants were grouped according to their areas, Lake Sebu and Tboli town. They were asked to make a quick inventory and assessment of their music. The activity drew varied responses from the different groups. Of interest were the differing opinions on which music they truly valued as their own and which were ones were in need of immediate “rescue.” It is crucial at this point to mention that much of the presentation of Tboli culture is in the context of tourism through short “cultural shows” for domestic and international tourists at the different resorts that ring the lake. These shows consist of the playing of a few music instruments such as a boat lute (*hegelong*), a flute (*sloli*), a mouth harp (*kumbing*), a small drum (*tnonggong*), some dancing, and the singing of an improvisatory welcome song. Infrequent are the singing of epic chants, ritual chants, or even the playing of music instruments in actual contexts. The result is musical forms that seem to have become more privileged than others as far as frequency of performance. The exercise of evaluating their extant music, therefore, allowed the participants to confront these seemingly ignored realities and to realize that certain musics were no longer being performed and heard.



FIGURE 3: The workshop at the School for Living Traditions in Lake Sebu (Photo by the author).

To the much older participants such as Susan Perong, a community leader and cultural division head of Tboli town, the data presented hinted of nostalgia as she recalled many musical practices in the past. It was also an opportunity for elderly people like her to see what the young participants knew about their musical culture. Symbiotically, the younger participants took the chance learn from the older generation and from others who were more knowledgeable about the music. Confronted with their musical cultures, the participants were forced to examine its current state and practice amidst the touristization and commercialization of Lake Sebu, and the continuous influx of migrants which has altered the production and consumption of Tboli culture. Remarks such as “I don’t hear that anymore,” or “I used to hear it when I was a still a small child” were common when certain songs or musical forms were performed or discussed during the workshop. With many cultural bearers having passed away and along with them their music, the community realized the need to record and archive. The recordings will not only preserve the music, but the presence of the performers themselves. To the Tboli, sound recordings are not just musics and sounds, but auditory presences of people.

The archiving project is still in its premature stage and subsequent workshops are planned. As of now, the Tboli are making recordings of their own music, writing field notes, cataloguing, and storing these. The community is documenting itself, not relying on outside researchers or leaders. They are working towards having a modest storehouse of audio and video recordings of their sound culture---products of their own collection efforts. I share in the belief with the community leaders that an archive resulting from the community’s own exertions empowers them as it gives them one more means to map out the future of their own culture.

SOUND ARCHIVING AND KARAOKE

One interesting output of the workshop is the discussion on the prevailing soundscape of karaoke in Lake Sebu. The Tboli are acutely aware of their sonic environment which provides fodder for much of their music, particularly instrumental music. However, for the past years, the blare of karaoke and dance music coming from the homes or eateries of lowland migrants, especially late at night, has resulted in tensions as the Tboli complain how it destroys the peacefulness of the surroundings. In the workshop, participants were confronted with reflexive questions such as: do I still hear the sound of birds? Insects? Streams? Waterfalls? All these, after all, are mimicked by musical instruments. The sound archiving project, therefore, engages the community to also record their natural soundscape as part of their intangible heritage. In their push to control the creeping noise pollution they can stake their claim by arguing that the soundscape is much a part of their intangible heritage as their music, dance, beadwork, embroidery, boat-making, and weaving. If they cannot win over the inaction of local authorities to control the noise pollution in spite of existing ordinances, perhaps a sonic heritage approach can help push for this. In addition, with the changing soundscape of Lake Sebu, archival recordings of the environmental sources of Tboli music itself provide a means by which the musical culture can be sustained.

THE HOLY CHURCH OF YAHWEH

The second aural community is a faith community⁴ based in Quezon City, a suburban area north of the capital city of Manila and comprising about 200 members. The community was founded 40 years ago by a woman referred today as the “founding mother” and has since grown to be a formal organization that calls itself The Holy Church of Yahweh. A single independent church not affiliated with any denomination, its religious beliefs and practices are a syncretism of Roman Catholicism, Born Again Christianity, Judaism, Buddhism, and its own beliefs as formulated by the founding mother and later by subsequent leaders upon the death of the latter.

Central to the community is the people’s acoustic relationship with sound and music which function as mediators between the divine and the human and by which the people engage and make material their faith. This is manifested in numerous rituals and celebrations such as the weekly “healing of the spirit” sessions in which people actively listen to sermons and loudly articulate prayers as part of the healing process. The content of these sermons includes preachings on the nature of God, practical instructions on one’s conduct of life, and trances in which deities such as *Diyos Ama* (God the Father) speak or sing. As such, the sermons inform the church’s collective and the people’s own ontology of their faith.

I have been doing work with the community for decades as part of my research in the acoustemology of new religious movements. In working with the church’s sound archives I became interested in how these materials came to be used as sonic landmarks of the people’s faith and its function in their religious practice.

⁴ The community prefers to refer to themselves as a faith community or a church rather than a religious group as they do not formally identify with a particular religious denomination.

THE COLLECTION

The collection consists of several dozen cassette recordings which have all been digitized. This is part of the larger archive holdings consisting of transcriptions of trances, log books, photographs, artefacts, and numerous paper documents which relate to the history of the community and of the founding mother.

The recordings were made from 1978 to about 1991 by some members so they can listen to the sermons over and over again and share it with others in the belief that one can still receive healing by listening to the recordings even if one is absent during the actual healing session. Since the passing away of the founding mother in 1992, cassette recordings of these sermons have become valuable archival materials to which the people continue to listen to as part of the community's healing practice. The recordings have also become reference materials for church practices and beliefs. When the Church splintered into three groups due to schisms in its leadership, each of these attempted to stake its legitimacy as the rightful church. There was an attempt to gather as many recordings as possible. The faction I am working with is the largest and claims to be the legitimate one as it is the one that adheres most closely to the practices of old. It also has the largest archival collection of recordings which further lends legitimacy to the community's claims. Being the holder of these sonic artefacts from which healing is received and theology is sourced, the archives become the instruments by which power is represented and staked.

ENGAGING WITH THE SOUNDS

I assist the community in organizing their archives through cataloguing and preservation of their collection, primarily their paper documents and audio recordings. What aroused my interest was the way the sound recordings functioned in the sacred practices of the church. The recordings offer a means for the members to engage with the divine sounds that is believed to emanate from them--- the trances, the voice of the founding mother, and the sounds of objects such as bells that accompany certain ceremonies. More importantly, the recordings allow the Church to continue its weekly healing of the spirit sessions.

The recordings have also become a means for the members to connect with their past often making references such as "... as said on the tape" or "...it's on the tape." In a way, these also function as a means to settle issues on dogma and practices. One only needs to listen to the recordings and hear what the founding mother said about certain issues. For the newer members of the church, listening to the recordings is an opportunity to experience a past that they never experienced, but which they can now claim to be part of. The recordings also give flesh to the founding mother, whom they only know through stories and photographs as video technology video technology was still economically prohibitive during that time. The archival recordings and people's listening practices to it are a means by which communal memory of the founding mother and the church as it was before is revived and sustained.

Corollary to this sound archiving project is the creation of an archive of the church's oral history as narrated by its members, particularly those who have been with the community since the time of the founding mother. While memoirs have been written, the oral narration of events and experiences add a layer of complexity in the narrative as it allows people to relive and describe the aural features of their faith. They are earwitnesses, (to use Schaffer's term) wherein remembrance and testimony are informed by their auditory experiences.

SUMMARY

Sonic archival recordings are not mute testimonies of a past. While their inherent value lies in whatever sound recording is encoded in the media, no less muted in value are the stories that shaped these and the people's continuous and sentient engagement with it. As the two case studies show, archives can be dynamic participants in people's everyday lives. If sound can be a way of knowing as Feld tells us, then the archives and its relationship with the people—the scholars and the heirs to these recordings are also a way of knowing. Sound archives, after all, act as a sort of insurance against the fragility of memory and memory holders.

My work with the two communities is still in its primary stages whose structure is largely determined by how the community feels about their own sonic culture and heritage and the path they wish to take. It is a process filled with negotiations on what they deem valuable, what the archives mean to them, and its function as an integral and dynamic part of the community. Reflexively, working with these communities was an opportunity for me to engage with the people in ways far different from what I was more accustomed. It allowed me to examine how I do my archival work and the innumerable ways it impacts the people. Working with the church community gave me the opportunity to examine religiosity from a sonic archiving perspective where archives are part of the quotidian aspects of sacred practice.

What I bring forth to the discipline of sound archiving is a process where archiving ultimately becomes community practice, representing sonic presences, and where people engage with archives not as mere artefacts of past traditions but as materials for sustainability. Sound archives are not just memories of sounds. They are deeply connected to the community itself, evoking presences, articulating beliefs, and sustaining practices.

REFERENCES

- Feld, Steven. "Acoustemology". *Keywords in Sound*. Edited by David Novak and Matt Sakakeemy. Durham/London: Duke University Press, 12-21.
- Foucault, Michel. 1972. *The Archeology of Knowledge and the Discourse of Language*. (A.M. Sheridan Smith, Trans.) New York: Pantheon Books.
- Said, Edward. 2014. *Orientalism*. New York: Knopf Doubleday Publishing.
- Schafer, R. Murray. 1993. *The Soundscape: Our Sonic Environment and the Tuning of the World*. Rochester: Destiny Books.
- Seeger, Anthony. 1986. The Role of Sound Archives in Ethnomusicology Today. *Ethnomusicology*, 30(2): 261-276.

MUSINGS ON THE ENGAGEMENT OF THE NEOPHYTE WITH THE ESTABLISHED ARCHIVE

Fredyl B. Hernandez

De La Salle – College of Saint Benilde, Manila, Philippines,
contact: fredyl.hernandez@benilde.edu.ph

Abstract

Music Production of De La Salle – College of Saint Benilde is a program first of its kind in the Philippines. Oriented to trail-blaze for 21st century Filipino musicians, the Music Production program is to be found not in a conservatory, but in a School of Design and Arts. As such, the program ensures responsiveness to the needs of the Creative Industries. With the government's Long-term Development Plan, wherein culture and the arts are seen as key social and economic capitals, something is to look forward for people who innately possess a certain degree of musicality whether in traditional, folk, popular, indie or in other formats. The program, to a certain extent, makes its own contribution in realizing this governmental thrust.

Situated in an amalgamation of cultural expressions as a result of historical determinations, sound and music culture in the Philippines feature a fusion of genres which also naturally results to distinct forms in the fusion and weaving processes. Recognizing this rich context, the program offers a wide variety of training to its students, and sensitive to the needs of the industry, outputs are always made relevant to the demands of the market and the society at large.

The capstone projects of the students as well as their other outputs from immersions and on-the-job trainings are in need of safeguarding and proper documentation. In the program's over two decades of existence, there is no good reason to wait for these outputs to become archaic in the future, acquiring the status of becoming objects or pieces of curiosities. The archival initiative is premised on the idea that these productivities entail a wealth of contemporary musical expressions nurtured in an emerging field of formal learning and mentoring. Offhand, there is a felt necessity of tracing the development of works. At the same time, as prompted by trends, the question to be asked now: What direction must the program take in order to be truly responsive to the industry as well as to actively engage in cultivating contemporary practices of music in the Philippines and in the world?

Lastly, the archive is also a soundscape. Akin to the recording of varied sounds simultaneously present in an environment, the archive becomes an instrument of digitizing culture and pedagogy – of recording thought and learning processes of young people as well as educational approaches and methodologies in the part of the program. The initiative seeks to explore the charting of pedagogical outputs – its domiciliation and consignment, and processes involved in its retrieval and dissemination.

Keywords

Performing arts, digitizing pedagogy, project outcomes, archiving of events, Philippines

I was enticed at first by the idea of considering present-day pedagogical outputs of a music-making degree program as potential materials for present day archiving. The reason behind this enticement is my context of belonging to a unit of relatively young higher education institution that maintains a thrust of keen responsiveness of arts, design, and culture to market and industry. To my mind, it would be an interesting endeavour to tease out the young and his creations with the established institution of the archive. The project in mind was premised on the idea that compositions of today are possible contents of the archive in the future. What I

imagine, therefore, is an archive that has a close conversation with the materials which are presently produced, in contrast to its reactionary role of scouting remnants such as historical documents, cultural artefacts, and audio-visual recordings from the past. I was stirred by the idea that contemporary art production belongs to the continuum of expression of communal memory and knowledge, and if we see the archive as a sort of repository of culture then it must have a dialogical relationship with the so-called new or the emergent. I envision an archive actively engaging itself with what is surfacing and developing and not simply a static body that waits for human creations to age.

It is a fact that these present-day outputs may naturally not conform to the condition of being tested by time and of embodying some distant memory which merit them to be placed in a well-guarded and maintained space for keeping. As mentioned earlier, I argue that these creations entail a contemporary way or mode of thinking and expression and that very fact suffices to be a good reason for these outputs to be placed in a repository of sorts, hopefully in a manner that is framed by an archivist, or at the very least an advocate of archival work, someone who treats the materials in relation to its use as future references. These music outputs can be treated as documents of thought and learning processes in pedagogical point of view. These are also concrete manifestations of learning approaches, methodology, and philosophy of the program and of the entire educational institution. They mirror not only the interests and concerns of our young people but as well as the educational standpoint of the academic institution. I envision the project as a sort of an archive of recent memories, which are articulated in contemporary musical compositions.

In starting however, to concretize my research in safeguarding pedagogical outputs, it seems to me that such kind of endeavour boils down to the concept of having a reliable structure of administrative safekeeping, an aspect that is naturally expected to be present in good academic program management. I realized that the movement of such inquiry necessitates a direction towards the creation of a sound model of institutional practice of systematic upkeep of artistic compositions of students. I decided not to pursue that direction for the reason that the archive and the archival work will be placed in the background. Instead, I chose to simply focus on some nuances entailed in the processes of establishing a more convivial relationship between new interests and perspectives, emergent orientations, including new users, with the established and time-honoured archive.

I belong to a cluster of academic programs¹ that carves a niche in the merging of professional art practice, arts and cultural management, and creative industries. I am part of a service department that maintains a thrust of interdisciplinary inquiry on arts and cultural studies. We have a Music Production program in our cluster which is relatively a young degree of almost two decades of existence. It's the first of its kind in the Philippines being a program that is oriented to trail-blaze for the 21st century Filipino musicians, or to use a more inclusive term, music practitioners. The needs, directions, and developments in the creative or cultural industries are important considerations in the program's design. For instance, outputs in the program are always making sure to be relevant to the demands of the market and the society at large. The program "... reflects the diversity of musical experience – mixing sounds, composing songs, producing musical performances – to ensure that ... learning remains relevant in the music business."² Also, one can say that the present global trend of how arts and culture are heavily boosted as key social and economic capitals that can bring long-term

¹ Our academic cluster's name is Benilde's Arts and Culture Cluster (BACC) of the School of Design and Arts, De La Salle – College of Saint Benilde, in Malate, Manila City, Philippines.

² <https://www.benilde.edu.ph/courses/tracks/ad/music-production.html>, last accessed 7 October, 2019.

development of third world countries,³ is somewhat resonated in the opportunities and trajectories that the program provides its students. With all these at the background, the program can be described as undoubtedly situated outside the usual concerns of the senior and established archive for the reason that its gaze is directed to what it's happening in the now rather than to what had happened in the past.

On the contrary, because an academic program intends to give a well-rounded education and skills development, to some extent, the students are expected to become natural users of the archive. Familiarization of the past, including those sources of influences from different cultures surely gives a good grounding to one's practice. In the Philippines, just like any nation-state which was once subjugated in the colonial structure, the spectrum of sound and music culture features a fusion of genres – Austronesian, Hispanic-European, American-Western, and indigenized. Recognizing this richness of the amalgamation and hybridity in the field as a result of historical determinations, the program offers a wide variety of training to its students in order to provide them with both local and global perspectives on how music developed as a field in the country. Music cultures, in both traditional and modern expressions, entail “unique musical systems with its own vocabulary” (Mirano, 1997: 145) which definitely predicates the appreciation and valuation of music as phenomena that simultaneously and uniquely taking place in various corners of the globe. Likewise, just like any other art form, music is also seen as a mediator in social interactions. In cultural studies, it can be perceived as a means that offers ways of “negotiating identity and (of) locating and relocating oneself in society” (Sirek, 2017: 55). With this, we see points of intersection between sound and music archives, and the complex undertaking of marking one's identity through artistic compositions. All music composers including student-artists who explore and create in the present join in that process of continuously creating, cultivating, and navigating cultures which entail both affirming and contesting identities. In an industry-related degree program, a facet of construction and reconstructions of identity is always being charted. Hence, the archive remains to be a helpful reference in obtaining a good grasp of the past which in turn will inform the direction of identity discourse through musical compositions.

The program is one of the thriving degree offerings of the school. It attracts a lot of young people who probably considered music as a hobby in high school perhaps as a member of a band, a choir, or a singing group, and eventually decided to pursue music in college. At present, there is an influx of students in the program which can still be considered as part of the first waves of graduates of the K-12 educational reform instituted seven years ago. The Philippines belongs to the last two countries in Southeast Asia that implemented the K-12 educational system. In this surge of enrollees, it is interesting to note that only a handful took Arts and Design track in their senior high school, an understandable thing as there are very limited number of senior high schools throughout the country which offer arts and design more so with a specialization in Music.⁴ This is the general background of the students who are joining the program. Their first terms in the program are crucial months of orienting them to the field that they are entering. Later, in their final year of stay, a certain sense of privileging to experimentation of contemporary forms are eventually given to students. They have the liberty to pursue the type of music which they would like to explore and pursue

³ The Philippine Development Plan 2017-2022 attest to this thrust. Subsector Outcome 3 under Chapter 7 (Promoting Philippine Culture and Values) aims to “Boost the development of Filipino creativity as a tool for cohesion and impetus for a culture-based industry and creative economy.” National Economic Development Authority. Philippine Development Plan 2017-2022: 101.

⁴ For example, I handled a block section in Art History class composed of freshmen Music Production majors, during the 1st term of the school year 2019-2020. Out of 30 students, only four attended the arts and design track in senior high school.

under the supervision of their faculty advisers. A general review of the students' outputs in almost two decades of the program shows that music technology heavily influenced the compositions. It generally bears the urban and the popular mark.⁵

My guideposts in this preliminary study involves a reflection on the following questions: How does a relatively young and contemporary music program makes sense of sound archives? What are the entry points of the program in the archive not only as a user but as a participant and contributor in expanding its discourses? What areas of productive engagement can an admittedly market or industry-driven program engage with the archive as an institution that places a premium on preservation and transmission of knowledge from the past? An important point to consider in these questions is the context of my musings that is not just limited to sound archival but to the archive in general and on how the public is presently engaging with it.

My first encounter with the archive was during my last year in high school. I remember that part of my thesis recital work at the Philippine High School of Arts, the first specialized school on arts-focused education in the country, was to obtain a sound recording of a Peking Opera excerpt at the College of Music, University of the Philippines Diliman. After going through the list of Chinese opera audio recordings, I was able to locate what I was looking for and record it using a blank cassette tape. The internet was not yet widely used at that time. It was during those years in which the CD ROM encyclopedia was considered as the edgy research tool of an ordinary student researcher. I handed over the recorded material I obtained from the archive to the head of our school's music program who assisted us in the live sound scoring of the production recital. We were fully aware at that time that it was not in our intention to create an authentic Peking Opera because we will never arrive to such kind of performance. Rather, our intent was born out of a noble desire to include cultural performances in Asia in our theater repertoire and not just be limited with the materials from European playwrights who are usually the ones to be found in the canon of drama.

This personal experience of the archive illustrates that action of retrieval of a record of an age-old tradition, a material from a totally foreign culture, for the purposes of familiarization as well as utilization of it as a jumping board for performance creation. Such experience demonstrates a picture of the practical usefulness of the archive to ordinary individuals who have very limited knowledge, to the novice, the neophyte, or to the uninformed who come from outside the ambit of arts, culture, or the very specialized field of sound archiving. After all, the archive maintains an attitude of openness to all, a willingness to accommodate anyone who may be in need of whatever it possesses. The rationale behind its creation is concretely realized when the public, experts and lay people alike, enter it and sift through its contents and eventually produce something out of what they have significantly gathered from the archive.

The guidepost questions I mentioned earlier are born out from my contemplations as regards the workshop's thrust on safeguarding strategies for sound archiving as well as informed by the arts and cultural program in my home base academic institution. Beyond those contexts, I also wish to tease out the general situation of archiving in the Philippines and on how the ordinary person or the novice can navigate and make sense of what our archives in the country offer. A closer scrutiny on the situation and practice in Philippine archiving reveals a situation that is very far from the level of sophistication of discourses and practices found among institutions from well-off nation-states. We have a government unit under the Office of the President, the National Archives of the Philippines, which keeps historical documents

⁵ Interview with Agnes Asunta Manalo, former Program Chair of Music Production, 08 July 2019.

mostly from Spanish colonial period. In May 2018, the administrative building of the national archives was hit by fire. Luckily, the principal collection was not destroyed as it was placed in another location in keeping with established institutional practice. Despite the many limitations it faces, the National Archive is continuously working hard on the digitization of its collection. As if with some sort of foreshadowing, the Faculty Center of the University of the Philippines Diliman, the headquarters of the professors of the College of Arts and Letters, and the College of Social Sciences and Philosophy, was totally destroyed by fire in 2016. Many lamented the great academic loss of volumes of research outputs as well as documentation and actual creative works of professors and students alike. It was truly an ill-fated event particularly to people who value the keeping of artistic and academic productivities. On the contrary, it paved the way for the university to seriously undertake a project on digital Humanities which involves the recording of performances including musical traditions from various cultural communities in the country.

In 2014 and 2015, I had a chance of cultural immersion to two remote villages in the town of Alimodian, Iloilo in the Western Visayan Region. I did some initial video recording of an indigenized Catholic ritual called *Sukat* or *Bungkag Lalaw* that marks the mourning period of a bereaved family. *Sukat* connotes a year that has already passed. Usually, the ritual takes place a year after the death of the family member but, in some instances, it is extended to two or three years depending on the capacity of the family to hold a feast. *Bungkag Lalaw* means end of mourning.⁶ In one village located on top of mountain ranges some 25-kilometer away from the town proper in the lowland, the ritual is officiated by a lead woman cantor who performs a pseudo-priestly role in the ceremony, like in officiating the act of blessing the altar and the house with water, and the chanting of a prayer text which is clearly recognizable as something based from the Latin language. A simple band composed of a guitar, banjo, trumpet, and bass drum accompanied the singing. The ritual was strongly marked by visuals such as a makeshift small coffin at the center surrounded by candles. The altar was draped with a black piece of cloth with a crucifix as well as other statues of saints, and food offering. The black cloth was removed towards the end part of the ceremony revealing a red cloth beneath it wherein once exposed marks the formal end of the family's mourning. A feast followed after the ceremony, and everyone in the community took part in it.

In the previous decades, a good number of anthropologists, particularly dance and music researchers have focused their studies on sound and music cultures of various communities in the Philippines. Seminal works were created in the 80s and in the following decades, but a lot of work has still to be done. There are knowledge systems that are already on the brink of extinction because they are no longer patronized even within the local community. Also, there are forms that are inherently ephemeral such as rituals and prayers that are being chanted but never written nor recorded. There are plenty of artistic and cultural expressions which need to be studied in a more nuanced way and be brought to the attention of individuals familiar to archival preservation. In many instances, written outputs of the researches were produced, but the materials gathered from the community, such as sound recordings were never properly kept.

There are two very important givens about the archive that I would like to revisit at this point. First, the archive bears a notion of age. As regards to what it holds, the contents of the archive

⁶ Online interview with Evelyn Amor, key informant from Mambawi, Alimodian, Iloilo, 08 March 2020. The house where I stayed during my immersion was just next to her residence. A distant relative of her family held a *Sukat* or *Bungkag Lalaw* during my stay in their village. It was my first time to witness the ceremony and listen to the chanting. The following year, I witnessed another *Sukat* ceremony in the upland village of Tabug, in a cluster of villages in the mountains called by the locals as Seven Cities.

implicate no simple number of years of presence but decades even centuries of existence. Whatever the archive holds must simply have gone through a lot. A sense of being able to endure the tests of time and of withstanding changes on various levels can easily be intuited even before going through what the archive holds. Second, the archive speaks of meaning. A thing is being archived because someone or a community places meaning to it, including the archivist. Akin to a curator who works on choices, whose selection of objects and pieces to be included in a display is informed by various considerations, the archivist makes sense of the objects included in the archive through a system of signification. To be placed in the archive means for the object to be charged with meaning. A thing persists inside the archive because its placement has been assigned with a certain relevance, and that assignment of value is recognized by systems supporting the archive.

There is a dimension to it as “selective shaping of remembered past”. (Craig, 2004: 9). Jacques Derrida calls these processes as domiciliation and consignation. (Derrida, 1995: 10). He describes that objects “... which are not always discursive ...” are mediated by a “legitimate hermeneutic authority.” In the context of maintaining a collection of objects from the past, that authority is named as the archivist. The processes he called “functions of unification, of identification, of classification...” are referenced to “the power of consignation” (Derrida, 1995: 10), or the authority to assign and formalize meaning. Of course, we know that Derrida’s investigation is situated in the understanding of memory as repository space, in the field of psychoanalysis, but his idea of authority and truth is instructive in understanding the nature of the work of the archivist. As a person of influence and power, he has an important role in providing direction for the archive’s collection including how it will be accessed and enriched by the public.

Natural and man-made calamities and other unfortunate events, such as fire which destroyed the research collection of some UP Diliman faculty members, as well as placed in danger the administrative records of the National Archives of the Philippines, necessitate a modern approach in archival. In our present state of advancement, it is but a natural move to take recourse to technology in preserving documents and records from the past. However, Barbara Craig poses a cautioning in this transfer of recording format for the reason that the fast-paced updating of what one holds eventually leads to very rapid even hyper systems of appraisal. In other words, because materials become readily available, the way of deciding what needs to be kept and discarded becomes a hasty process as well. The more we are attached to the electronics, such as the soft copy of documents and recordings, “the greater will be the urgency to appraise. Rather than allowing us to order and keep everything, digital records are notoriously fragile. (Craig, 2004: 10). Her statement is based on the trend of how documents are evaluated whether to be kept and be made available in the archive due to this fast-paced availability of materials. In the Philippines, the pressing challenge for the time being remains to be the same: transfer the format of recordings from analog to digital. We are not yet in a situation wherein the collection is already saturated by the digital files. For now, digital archives are not yet distressed by the volume of works that it needs to maintain. Craig’s reflection is a forewarning of what may eventually come after fulfilling the present clamour of making things digital.

As an archive-user, researcher-scholar on arts and cultural studies, and an advocate of an expanding reach and utilization of the archive, I would like to go back to the envisioned state of engagement of the young and emerging with the established and time-honoured archive as the main premise of this study. Again, the ideas of Derrida are useful in this endeavour in terms of how the archive’s processes of reflexivity entail a dimension of listening to its users. He said that “democratization involves the participation in and the access to the archive, its constitution, and its interpretation.” Perhaps a concrete elaboration of these ideas, particularly

its implications in contemporary mode of archiving is to be found in the observations of Clifford Lynch in his studies on the digital. He describes that this technology characterized by electronic tools, systems, devices, and resources, comes an apparent absence of natural communities which used to surround traditional cultural heritage materials deposited in the archive. Whatever that is placed in the digital becomes available to anyone at any place and at any time.

The reach even extends to “very strange and exotic places that you wouldn’t have imagined, and sometimes (users) make extraordinarily creative or unpredicted uses of that material. Lynch proceeded with a general caution that “perhaps we should avoid over-emphasizing pre-conceived notions about user communities when creating digital collections.”⁷ This does not definitely mean that we should stop understanding the emerging users of the archive but it is rather a challenge to expand our imaginations regarding these users as well as the end goal of the utilization of materials obtained from the archive. The more we engage these new set of users, these neophytes, in the direction of the archive, the more that a reflective attitude is formed. And reflexivity indicates life. It suggests an avoidance of the notion of the archive as an archaic institution and a stagnant space.



FIGURE 1: Current audiences of open air performances at the University of the Philippines Diliman (Photograph by courtesy of <https://upd.edu.ph/celebrating-the-seasons-music/> last accessed 30 May, 2020).

⁷ The work of Clifford Lynch was mentioned in David Thomas, Simon Fowler, et al, 2017: 70.

REFERENCES

- Amor, Evelyn. 2020. Online interview with the author. Mambawi, Alimodian, Iloilo, on 8 March.
- Asunta Manalo, Agnes. 2019. Interview with the author on 08 July.
- Craig, Barbara. 2004. *Archival Appraisal, Theory and Practice*. München: De Gruyter.
- Derrida, Jacques. 1995. *Archive Fever: A Freudian Impression* (transl. by Eric Prenowitz). *Diacritics*, 25 (2): 9-63.
- Mirano, Elena R. 1997. Sound in Music Culture. *Art and Society*. Edited by Patrick D. Flores. Quezon City: University of the Philippines Diliman, p.145.
- Music Production Program. <https://www.benilde.edu.ph/courses/tracks/ad/music-production.html>, last accessed 07 October 2019.
- National Economic and Development Authority. 2017. *The Philippine Development Plan 2017-2022*, abridged version. Pasig City: www.neda.gov.ph. Last accessed 14 May, 2020.
- Sirek, Danielle. 2017. Our culture is who we are! “Rescuing” Grenadian Identity through Musicking and Music Education. *International Journal of Music Education*. 36 (3): 47-57.
- Thomas, David, Simon Fowler, et al. 2017. *The Silence of the Archive*. London: Facet Publishing.

TECHNOLOGY IN SUPPORT OF LANGUAGES OF THE PACIFIC: NEO-COLONIAL OR POST-COLONIAL?

Nick Thieberger

University of Melbourne, contact: thien@unimelb.edu.au

Abstract

The Pacific and Regional Archive for Digital Sources in Endangered Cultures (PARADISEC) has been digitising recordings of traditional cultural expression, oral tradition, and music (TCE) for 17 years. A major motivation for this work is the return of these recordings to where they were made. On the one hand there is social justice in preserving records of languages that are under-represented in the internet and cultural institutions, and making them accessible in what can be characterised as a postcolonial restitution of these records. On the other hand, if it is first world academics doing this work, it risks being yet another colonial appropriation of Indigenous knowledge. In this paper I explore some of these issues to help set directions both for our own work, and for future similar projects.

“From ancient times to the present, disquieting use has been made of archival records to establish, document, and perpetuate the influence of power elites.” (Jimerson, 2007: 254).

A quarter of the world’s languages are found in the Pacific. In communities sustained over many hundreds of years by local economies, the globalised world impinges through urbanisation and encroaching metropolitan languages, particularly in media, accelerating language change and language shift. Technology, in the form of computers, digital files, and ways of working with them, is a first world product, access to it is costly, and the interface to it is never in a local language but always in a major metropolitan language. Training and experience in using technology is not easily obtained, leading to a divide between those who are able to use it and those who are consumers of it, typically via expensive internet connections. How can a new kind of archival enterprise “establish, document, and perpetuate” the languages and their speakers, in order to counter what Jimerson calls the influence of power elites.

Keywords

Technology support, Metropolitan language, Pacific region, Traditional cultural expression

Linguistic research has been actively pursued in the Pacific since first colonisation, by missionaries, and later by academic researchers. This, and the work of others, including musicologists and anthropologists, created primary records of traditional cultural expression (TCE) which can be of great interest to the source communities for whom there are few records available, especially in public spaces such as the internet, libraries, and so on. Errington (2001) provides a critique of what he considers to be the colonial nature of linguistics, focussing on the project of reifying language varieties as standard forms, developing writing systems for them, and using languages in Christian proselytising. It is not surprising that linguistics, just as any other part of the imperialist project, can be critiqued as colonial in this way. However, I am more concerned in this discussion to consider the practice of academics in the past, who, in general did not provide a means for curating recordings and making them accessible for the source communities, and to contrast that with the possibility of restitution of expropriated primary records – recordings, photographs, and so on.

Here, I want to present a practical notion of responsibility with regard to recorded TCE, one that I suggest is post-colonial in simply providing access to recordings for people whose languages and cultures were earlier treated as objects of study. These recordings are otherwise at risk of being lost, but potentially have value as some of the few records available in a local language. The responsibility is that of academics to ensure that records made with indigenous

people are available to those people as soon as possible after they are recorded. A further responsibility for the research community is locating existing analog recordings made in the past and making them available for use by speakers today. In this way, and as Jimerson (2007: 256) notes, archives contribute to the public interest “by documenting underrepresented social groups and fostering ethnic and community identities.” Similarly, Smith observes that

“imperialism and colonialism brought complete disorder to colonized peoples, disconnecting them from their histories, their landscapes, their languages, their social relations and their own ways of thinking, feeling and interacting with the world. It was a process of systematic fragmentation which can still be seen in the disciplinary carve-up of the indigenous world: bones, mummies and skulls to the museums, art work to private collectors, languages to linguistics, ‘customs’ to anthropologists, beliefs and behaviours to psychologists. To discover how fragmented this process was one needs only to stand in a museum, a library, a bookshop, and ask where indigenous peoples are located.” (Smith 1999: 28)

I suggest that the process of making records of TCE available addresses some of Smith’s concerns, but I begin by briefly sketching the colonial nature of academic research that is based in fieldwork among indigenous people. This is necessarily brief as I take it to be self-evident that the academic research enterprise, especially in the early to mid-late twentieth century, regarded speakers of indigenous languages as sources of information, and rarely as participants in the research. Recordings were typically not made available to those people, and, as will be clear from the effort required to find and digitise these recordings, provision was not made for the recordings to be suitably housed so that they could be accessed into the future.

Linguistics has, as one of its objects, the study of each of the world’s languages, typically requiring fieldwork in which a linguist goes to live in a village to learn the language and to write an analysis of it, in the form of a grammatical description. This is critically important in linguistics and can be likened to taxonomic work in biology. This basic research strengthens theoretical claims by expanding the number and type of languages included in the typological analysis.

In the past there has been little awareness of the extractive nature of this work, and a corresponding lack of attention paid to creation of materials that could be of use to the local community. We can see this reflected in how published guides to fieldwork, produced to train new linguists, characterise or else ignore linguistic data management – the necessary prerequisite for preserving the records made during fieldwork. Most such guides offer sample wordlists and sample sentences for elicitation (e.g. Bouquiaux and Thomas, 1992; Samarin, 1967). Some go further and briefly discuss issues around preparation for fieldwork (e.g. Abbi, 2001; Vaux and Cooper, 1999). The anthropologists Fischer (2009) make no mention of ‘data’, ‘recordings’, or ‘archiving’. While Bouquiaux and Thomas (1992) and Newman and Ratliff (2001) include advice about recording techniques, neither mentions ‘data’, or ‘archiving’ of the recordings. Similarly, none of these cases considers the possibility of speakers wanting recorded language material for later reuse. The linguistic discipline’s focus on elicited sentences and ‘pure’ or ‘traditional’ language (as seen in these fieldguides) mean that the records do not reflect everyday spoken interactions and so are of limited use in language revitalisation efforts (Amery, 2009).

By the turn of the 21st century, we see fieldguides that are starting to pay attention to linguistic data management. Crowley (2007), Chelliah and de Reuse (2010), and Bower (2008) discuss archiving and data management, and Thieberger and Berez (2012) is a chapter devoted to methodology for creating and archiving linguistic records in a fieldwork volume focused on interdisciplinarity in fieldwork (Thieberger, 2012). The most up-to-date guide is Meakins, Green and Turpin (2018: 73-95), which provides detailed information about data management and archiving. More information on the changes in language recording practice over the past

generation can be found in Thieberger (2016), but it will simplify our discussion to characterise the new approach to fieldwork and resulting material as *language documentation* (Himmelmann, 1998). Lest it appear that these advances in methodology have succeeded in changing all fieldwork practice, there are still recalcitrants for whom considerations of data sharing and archiving are a distraction from what they consider to be the *real* work of academic research. For example, Aikhenvald (2007: 7) claims that technology is itself neo-colonial,

“[t]here is no doubt that putting conversations, texts and other information on the world wide web, and producing videos and web-based archives, is close to the heart of many of our computer-loving linguistic colleagues. ... Putting web-based data together may be easier and quicker than painstakingly writing a grammar, and producing a competent dictionary. But web-based archives need constant updating, and book pages do not. And if a language is spoken in a remote community, say, in Amazonia, Africa or New Guinea, what use is a website to them?”

Here we see technology represented as colonial and inaccessible to remote communities, a seemingly reasonable critique, after all, electricity is not common in many remote areas, and, if internet access is available, then bandwidth is expensive. However, the basic premise of this argument is that, in response to the lack of access in some geographical areas, we, as academic researchers, should not create digital files and archive them, seemingly a non sequitur, until one sees that Aikhenvald confuses archives, which are long-term repositories, with websites, which we have come to learn, often to our cost, are a transient presentation of information. This kind of argument ignores our responsibility to create re-usable primary records and does not understand that creating proper records with the best methods now will also allow it to be returned to the community in various formats that can be accessed now. It fails to acknowledge that access to the internet is ever-expanding, with the result that, at some point in the not too distant future, people in even the most remote locations will be searching for their language records online.

Another reaction against appropriate language data management methodologies is Dobrin, Austin and Nathan (2007) who reject the need for standards in metadata and file formats in linguistic research. These authors say that, “quantifiable properties such as recording hours, data volume, and file parameters, and technical desiderata like ‘archival quality’ and ‘portability’ have become commonplace reference points in assessing the aims and outcomes of language documentation [...] technical parameters such as these are now foregrounded to the point that they are eclipsing discussions of documentation methods.” (Dobrin, Austin and Nathan, 2007: 62) There is no basis for this assertion and it must be pointed out that, without the use of community-agreed standards for file formats, file management and archiving are made more difficult. Simple guidelines provided by archives to linguists allow the creation of ‘archive-ready’ material that can be accessed by the linguist and the speakers of the language in future.

It is of some small comfort to note that, despite this kind of backlash, the field of language and music archiving is probably more advanced than is the case for other disciplines. There is an international community of digital archives in the Digital Endangered Languages and Musics Archives Network (DELAMAN¹), and the Open Language Archives Community² (OLAC) has, since 2000, provided a set of standard metadata terms for archives to use in describing items in collections. Because of this international standard, OLAC can harvest metadata from each of the member archives, building an aggregated directory of all their contents that is refreshed

¹ <http://delaman.org>, last accessed 28 May, 2020.

² <http://www.language-archives.org/>, last accessed 28 May, 2020.

daily. This then creates a webpage for each language in the world, listing what is available in all of the participating archives for that language.

The virtuous post-colonial environment I have been portraying so far is only partially altruistic. In reality, the nature of research data management has changed in the past decade so that many of the issues that characterise language documentation also have currency across all disciplines, and are being led by the sciences, for whom primary data has always been regarded as integral to research (e.g. Tenopir et al, 2011). So, while it is still controversial among some linguists (among them those cited above) that we work with data at all, and that we need to pay attention to data management, it is much clearer in science disciplines that data must be citable and experiments must be replicable. Digital data has also facilitated the rapid transfer of files, stored in multiple locations, but its evanescence (Thieberger, 2018) prompts us to concentrate on backup and data management techniques, including building repositories to curate files in the longterm.

There is an increasingly large cohort of newly trained linguists and musicologists who take seriously the need to produce re-useable records in the course of their research, and to archive them as soon as possible, in order to create citable data they can use in their research³. There is a prize⁴ offered for the best collection of primary data created by an early career researcher. There are policy suggestions for acknowledging properly curated primary data collections as valid research outputs (Thieberger et al, 2016), and discussions of citation practices for primary data (Berez-Kroeker et al, 2019). Taken together, this practice acknowledges the professional responsibility of researchers to ensure their work is accessible to the people they work with. Even this small effort should be seen as post-colonial practice, and incorporated into training for current and future fieldworkers.

REPATRIATION

The practice of repatriating Indigenous human remains (Fforde and Ormond-Parker, 2001) is well-known and continually developing⁵. Equally well-known are the egregious examples of collecting agencies that will not return material, clinging instead to the vestiges of their colonial past. A related activity is repatriation of cultural materials, including audio, video, or manuscript records. Such collections could be the result of fieldwork by an outside researcher, or be made by speakers of their own communities. In Vanuatu the fieldworkers in the Vanuatu Kaljoral Senta (VKS) made many recordings that are today held in the museum building in Port Vila. One of the foundational fieldworkers, James Gwero, did this work, because “people were saying the white men had come and stolen their voices” (Kapere, 2011:137) and he was determined that his recordings would instead be held by the VKS. However, there is a risk in analog tapes being held in just one location as illustrated by the fire at the National Museum of Brazil in September 2018 that destroyed many unique paper and recorded materials in languages of Brazil.

In the past, analog recordings relied on there being local machines that could play reel to reel tapes or cassettes. Even with the occasional return of an analog tape to its source community, analog media deteriorated with each playback, and required dry and dust-free conditions to be stored in, something that was not always possible in dry, dusty, or humid environments. Analog tapes, by their nature, are not easily copied, and getting analog records back to the places they

³ These notions crystallised in the wider research community into the FAIR principles³, published in 2016, which set out the goals of Findable, Accessible, Interoperable, and Re-usable research data. Each of these principles is reflected in the practice developed by PARADISEC, as discussed here and in Barwick and Thieberger (2016).

⁴ <http://www.delaman.org/delaman-award/>, last accessed 28 May, 2020.

⁵ Project ‘Return, Reconcile, Renew’, <https://returnreconcilerenew.info>, last accessed 28 May, 2020.

came from has been an arduous task in the past that was usually not undertaken, in no small part due to a colonial approach in which information is extracted for the benefit of the researcher alone.

Digitisation provides a means for making records available and for storing them in the longterm, in several locations as, unlike their analog sources which deteriorate with each generation of copying, each digital copy is identical. Digital archiving and delivery of records changes access and promises a shift towards a post-colonial practice, while at the same time highlighting the technological gap between the local community and the archive. These are issues we are addressing in our work at the Pacific and Regional Archive for Digital Sources in Endangered Cultures (PARADISEC)⁶, a project running since 2003 that seeks analog ethnographic recordings, digitises them, and makes them available online (subject to conditions established by depositors). We have so far put 12,400 hours of recordings online, each with licences for use, representing 1,235 languages. As with any collection hosted in a first-world country we are aware that we perpetuate appropriation of cultural material, however, it would be equally problematic to ignore the importance of preserving cultural records and of making them available to the people represented in them. Further, as should be clear from the discussion here, digital records can overcome the inherent problem of the analog in that digital records can be made available in many places and over time in a way that analog records could not.

In addition, we are actively working with a range of cultural agencies in our region to make the recordings known to them, to provide copies of recordings, and to support their own efforts to digitise their collections of analog records. For example, we have applied for and received grants to digitise hundreds of analog tapes from the Solomon Islands National Museum⁷, The University of French Polynesia⁸, and the Divine Word University in Madang (PNG)⁹. PARADISEC have been working with the VKS and have digitised more than 200 of their tapes, including many open reels that were mouldy and for which there was no playback machine in Port Vila¹⁰.

Recordings in some of the many languages of the Pacific can be found in collections all over the world, along with the artefacts and other cultural items taken in the colonial enterprise. These collections may be housed in institutional libraries or similar repositories, or, more often, they are found in the offices of researchers, in their houses once they retire, or in their deceased estates once they die, in general, they are not treated with the respect they deserve.

We set up an online questionnaire called ‘Lost and Found’¹¹ and periodically seek information about ‘orphaned’ collections of oral tradition on analog tape that need to be preserved. These include tapes in deceased estates, or tapes in offices and homes of older or retired researchers. As a result, we have digitised many collections of field recordings that would otherwise have been lost, as there are too few digital archives that focus on this kind of material. One major collection we have digitised was made by the Catholic priest Fr John Z’graggen in the region around Madang in PNG from the 1960s onwards. It was held in the Basel Museum in Switzerland (172 tapes), and some copies and originals were also stored in Madang at the Divine Word University (180 tapes). After long negotiations with the Basel Museum they agreed to have the entire collection digitised and, rather than shipping tapes to Australia, we

⁶ <http://paradisec.org.au>, last accessed 28 May, 2020.

⁷ <https://catalog.paradisec.org.au/collections/SINM>, last accessed 28 May, 2020.

⁸ <https://catalog.paradisec.org.au/collections/EC1>, last accessed 28 May, 2020.

⁹ <https://catalog.paradisec.org.au/collections/DWU>, last accessed 28 May, 2020.

¹⁰ <https://catalog.paradisec.org.au/collections/VKS2>, last accessed 28 May, 2020.

¹¹ <https://www.delaman.org/project-lost-found/>, last accessed 28 May, 2020.

arranged with our colleagues at the Max Planck Institute in Nijmegen to have them digitised there and then made available for us to archive¹². We applied for and received funds from the Endangered Languages Documentation Programme's Legacy Materials Grants and worked with the DWU to digitise those tapes from Madang¹³. With a similar grant, we digitised 260 tapes in To'aba'ita (Solomon Islands) that were in the retired researcher's house¹⁴ in Christchurch, New Zealand, and then sent copies of the files to the Solomon Islands National Museum.

The list of taped collections at risk keeps growing, despite the work of PARADISEC and similar allied efforts. At the same time, we are facing the imminent demise of audio carriers – analog tapes are not expected to be playable in the very near future, and playback machines are slowly going out of service (National Film and Sound Archive, 2015).

We increase the reach of our catalog¹⁵ via feeds to external services such as OLAC (mentioned earlier), the Open Archives Initiative, Research Data Australia¹⁶, and the National Library of Australia's Trove¹⁷. These feeds are then picked by other services and so make our collection more visible in a number of search tools, like the Virtual Language Observatory¹⁸. We are also building methods for delivering sub-collections of items on local WIFI transmitters¹⁹, aimed at regional cultural centres. This has the advantage of avoiding expensive and slow internet connections, and of being available on smartphones which are becoming increasingly common in Pacific island nations. We have written a tool, the 'data-loader'²⁰, that runs over a selection of arbitrarily grouped items from the collection, each of which is stored together with a file of its own metadata description. This then generates a static catalog of just the selected files and makes the collection more meaningful for a user than would be a set of files that are divorced from the catalog. The html catalog is designed to work either on a hard disk or on a raspberry pi WIFI transmitter to make the collection available in the most suitable way for local access. We have trialled this at various locations in the Pacific and found it to be an appropriate and relatively simple way to make archival materials available to mobile phone users, avoiding internet costs. As data is stored on a usb device, we can envisage sending collections to local cultural centres over time. All of this helps in restitution of cultural records.

There is a choice to be made between doing nothing about the cultural heritage we and our forebears have recorded, and so allowing it to be lost, or to take some action to ensure it is available to the people most interested in it. As Chambers et al (2002: 214) note:

“simple inaction is almost always the worst choice to make. “Doing nothing” is actually a choice too. ... Thoughtful repatriation of ethnographic materials can assist not only in the decolonization of anthropology, but in empowering both communities and the people who comprise them by allowing easier access to a greater range of ethnographic information.”

¹² <https://catalog.paradisec.org.au/collections/JZ1>, last accessed 28 May, 2020.

¹³ <https://catalog.paradisec.org.au/collections/DWU>, last accessed 28 May, 2020.

¹⁴ <https://catalog.paradisec.org.au/collections/IF01>, last accessed 28 May, 2020.

¹⁵ <https://catalog.paradisec.org.au>, last accessed 28 May, 2020.

¹⁶ <https://researchdata.andcs.org.au/paradisec-collection/>, last accessed 28 May, 2020.

¹⁷ <https://trove.nla.gov.au/result?q=nuc%3A%22NU%3APAR%22>, last accessed 28 May, 2020.

¹⁸ <https://vlo.clarin.eu>, last accessed 28 May, 2020.

¹⁹ <https://language-archives.services/about/pi>, last accessed 28 May, 2020.

²⁰ <https://language-archives.services/about/data-loader>, last accessed 28 May, 2020.

CONCLUSION

The race to digitise analog recordings is our responsibility, as linguists, musicologists, and anthropologists, both in order to honour the work of our academic forebears, and to complete the more modern research cycle of repatriation of recordings. While the relationship between academics focussed on a research topic and speakers of a language will always be fraught with power imbalance, making recordings and returning them to the community is a necessary and increasingly common form of exchange. To the extent that we are making available the records that we created with speakers of languages we study, this activity can be considered postcolonial restitution. I have shown that a repository like PARADISEC can provide access to recordings and so avoid the grace and favour approach that was often the only way that recordings could be obtained in the past.

REFERENCES

- Abbi, Anvita. 2001. *A manual of linguistic fieldwork and structures of Indian languages*. München: Lincom Europa.
- Aikhenvald, Alexandra Y. 2007. Linguistic fieldwork: setting the scene. *Sprachtypologie und Universalienforschung* [Language Typology and Universals], 60(1): 3-11.
- Amery, Rob. 2009. Phoenix or Relic? Documentation of Languages with Revitalization in Mind. *Language Documentation & Conservation* 3(2):138-148.
- Barwick, Linda and Nick Thieberger. 2018. Unlocking the archives. *Communities in Control: Learning tools and strategies for multilingual endangered language communities. Proceedings of the 2017 XXI FEL conference*. Edited by Vera Ferreira and Nick Ostler. Hungerford: FEL, 135-139.
- Berez-Kroeker, Andrea L. Lauren Gawne, Barbara F. Kelly, Tyler Heston, Susan Kung, Gary Holton, Peter Pulsifer, David Beaver, Shobhana Chelliah, Stanley Dubinsky, Richard Meier, Nicholas Thieberger, Keren Rice and Anthony Woodbury. 2018. Reproducible research in linguistics: A position statement on data citation and attribution in our field. *Linguistics* 56(1): 1 - 18.
- Chambers, Anne, Keith S. Chambers, David R. Counts, Dorothy A. Counts, Suzanne Falgout, Nancy Guy, Alan Howard, Sjoerd R. Jaarsma, Mary McCutcheon, Bryan P. Oles, Karen M. Peacock, and Amy Ku'uleialoha Stillman. 2002. Returning Ethnographic Materials. *Handle with Care: Ownership and Control of Ethnographic Materials*. ASAO Monograph Series, no. 20. Edited by S. R. Jaarsma. Pittsburgh: University of Pittsburgh Press, 211-214.
- Dobrin, Lise M., Peter K. Austin and David Nathan. 2007. Dying to be counted: the commodification of endangered languages in documentary linguistics. *Proceedings of Conference on Language Documentation and Linguistic Theory*. Edited by Peter K. Austin, Oliver Bond & David Nathan. London: SOAS, 59-68.
- Bouquiaux, Luc and Jacqueline Thomas, eds. 1992. *Studying and describing unwritten languages*. Dallas: Summer Institute of Linguistics.
- Bowern, Claire. 2008. *Linguistic Fieldwork. A Practical Guide*. New York: Palgrave Macmillan.
- Chelliah, Shobhana L. and Willem J De Reuse. 2010. *Handbook of Descriptive Linguistic Fieldwork*. Dordrecht: Springer Science & Business Media.
- Crowley, Terry. 2007. *Field Linguistics*. Oxford: OUP.
- Errington, Joseph. 2001. Colonial linguistics. *Annual Review of Anthropology* 30: 16-39.
- Fischer, Michael M. 2009. *Fieldwork Is Not What It Used to Be: Learning Anthropology's Method in a Time of Transition*. Edited by James D. Faubion and George E. Marcus. Ithaca/ London: Cornell University Press.
- Fforde, Cressida and Lyndon Ormond-Parker. 2001. Repatriation Developments in the UK. *Indigenous Law Bulletin* 5(6): 9-13.
- Himmelman, Nikolaus. 1998. Documentary and Descriptive Linguistics. *Linguistics* 36(1): 161-196.
- Jimsonson, Randall C. 2007. Archives for All: Professional Responsibility and Social Justice. *The American Archivist* 70 (2): 252-281.

- Kapere, Jacob. 2011. Vanuatu National Film Unit. *Working Together in Vanuatu: Research Histories, Collaborations, Projects and Reflections*. Edited by John Taylor and Nick Thieberger. Canberra: ANU Press, 133-140.
- Meakins, Felicity, Jennifer Green and Myfany Turpin. 2018. *Understanding Linguistic Fieldwork*. London: Routledge.
- National Film and Sound Archive (Australia). 2015. *DEADLINE 2025 - Collections at Risk* Canberra: NFSA.
- Newman, Paul, and Martha Ratliff, eds. 2001. *Linguistic Fieldwork*. Cambridge: Cambridge University Press.
- Samarin, William. J. 1967. *Field Linguistics: A Guide to Linguistic Field Work*. New York: Holt, Reinhart, and Winston.
- Smith, Linda Tuhiwai. 1999. *Decolonizing Methodologies: Research and Indigenous Peoples*. London ; New York : Zed Books ; Dunedin, N.Z. : University of Otago Press.
- Tenopir, Carol, Suzie Allard, Kimberly Douglass, Arsev Umur Aydinoglu, Lei Wu, Eleanor Read, Maribeth Manoff and Mike Frame. 2011. Data Sharing by Scientists: Practices and Perceptions. *PLoS ONE* 6(6): e21101.
- Thieberger, Nick, ed. 2012. *The Oxford Handbook of Linguistic Fieldwork*. Oxford: OUP.
- Thieberger, Nick. 2014. Curation of Oral Tradition from Legacy Recordings: An Australian Example. *Oral Tradition*, 28 (2): 253-260.
- Thieberger, Nick. 2016. Documentary Linguistics: Methodological Challenges and Innovatory Responses. *Applied Linguistics*, 37 (1):88-99.
- Thieberger, Nick. 2018. Research methods in recording oral tradition: Choosing between the evanescence of the digital or the senescence of the analog. *Research Methods in the Digital Humanities* Edited by Lewis Levenberg, Tai Neilson and David Rheams, (eds) Cham: Palgrave Macmillan, 233-241.
- Thieberger, Nick and Andrea Berez. 2012. Linguistic Data Management. *The Oxford Handbook of Linguistic Fieldwork*. Edited by Nick Thieberger. Oxford: OUP, 90-118.
- Thieberger, Nick, Amanda Harris and Linda Barwick. 2015. PARADISEC: Its History and Future. *Research, Records and Responsibility: Ten Years of the Pacific and Regional Archive for Digital Sources in Endangered Cultures (PARADISEC)*. Edited by Amanda Harris, Nick Thieberger and Linda Barwick. Sydney: Sydney University Press, 1-16.
- Thieberger, Nick, Anna Margetts, Stephen Morey and Simon Musgrave. 2016. Assessing Annotated Corpora as Research Output. *Australian Journal of Linguistics*. Vol 36 (1), 1-21.
- Vaux, Bert, Justin Cooper and Ben Tucker. 2007. *Linguistic Field Methods*. Eugene: Wipf & Stock.

WEB PAGES

- catalog.paradisec.org.au, last accessed 28 May, 2020.
- catalog.paradisec.org.au/collections/DWU, last accessed 28 May, 2020.
- catalog.paradisec.org.au/collections/EC1, last accessed 28 May, 2020.
- catalog.paradisec.org.au/collections/IF01, last accessed 28 May, 2020.
- catalog.paradisec.org.au/collections/JZ1, last accessed 28 May, 2020.
- catalog.paradisec.org.au/collections/SINM, last accessed 28 May, 2020.
- catalog.paradisec.org.au/collections/VKS2, last accessed 28 May, 2020.
- delaman.org, last accessed 28 May, 2020.
- language-archives.services/about/data-loader, last accessed 28 May, 2020.
- language-archives.services/about/pi, last accessed 28 May, 2020.
- paradisec.org.au, last accessed 28 May, 2020.
- researchdata.ands.org.au/paradisec-collection/, last accessed 28 May, 2020.
- trove.nla.gov.au/result?q=nuc%3A%22NU%3APAR%22, last accessed 28 May, 2020.
- vlo.clarin.eu, last accessed 28 May, 2020.
- www.delaman.org/delaman-award/, last accessed 28 May, 2020.
- www.delaman.org/project-lost-found/, last accessed 28 May, 2020.
- www.language-archives.org/, last accessed 28 May, 2020.

EXTRACTING AUDIO SIGNALS FROM 4-TRACK ANALOGUE TAPE AND DIGITAL STANDALONE MULTITRACK MACHINE MATERIAL AS A PART OF PRESERVATION

Ahmad Faudzi Musib

Department of Music, Faculty of Human Ecology, Universiti Putra Malaysia,
contact: faudzimusib@upm.edu.my

Abstract

In facing ever-growing technology of audio peripherals, there is a concern of balancing in delivering technical knowledge to students dealing with audio recordings in the Music Department at Putra University, Malaysia (UPM). It seems to be difficult for them to do current multitrack recordings and at the same time maintaining the aesthetic aspect of past technology. In other words, if one preserves the recorded item, they have also to care about the specific features coming with these recordings. It is not the primary recorded subject alone they may have to consider. There is an urgency to migrate the recorded material such as cassette tapes that come in varying forms ranging from Ferric-Oxide, to Cro2, and Metal. These carriers are warranted to be extracted and migrate onto a more stable medium, not only in general as everywhere in the world, but also since it has become the university policy that equipment's exceeding certain years will be disposed of. The selection focuses on the recording materials that includes live musical performances, multitrack musical compositions, and final recording projects. In this context the 'recording' may just mean the audio information. It is important for any archive to establish a general policy with regard to the limits of its collection as was pointed out repeatedly (Schuursma, 2010). Viewing from the perspective of preservation (Musib, 2015) of content, a lack of awareness in handling these carriers may lead to complications when extracting the signal from still available machines. The paper is intended to discuss the challenges and requirements in the process of signal extractions using exemplarily the two formats, namely the 4-track recorder and the digital standalone multitrack machine.

Keywords

Signal extraction, 4-track cassette recorder, digital standalone multitrack recorder, cassette types, sound aesthetics

BACKGROUND

During its early establishment, the Department offered three focus areas for music majors. Bachelor's degree in music performance, music education, and music technology. Later to single major and that is Music Performance, and now it became Bachelor of Music offers a four-year program that focuses on classical performance, jazz performance, album production, music technology, music composition, music education, music therapy, ethnomusicology, and musicology. Since then, the Department of Music at the Faculty of Human Ecology, University Putra Malaysia, has undergone several curriculum revisions.

Although it is a single program, infrastructure is of major concern. It implies that, apart from owning the infrastructure, it is the responsibility of the Department to maintain the equipment and ensure that the equipment works in its optimum condition. The ISO (International Organization for Standardization) system is used to ensure that the musical instrument is

functioning at its optimum level. The process aims to ensure the satisfaction of the client (students). That requires the control of the location of its operation and the regular maintenance schedules for the services necessary. In the ISO system (Standard Popular, 2008), every equipment purchased by the university shall receive serial number (barcode) stickers. This is to indicate the equipment details. Figure 1 is an example of the form used when a piece of new equipment, namely an audio mixer purchased in 2016.

Search				Asset Individual Details for Universiti Putra Malaysia - Serdang			
Asset Number:	S00635204	Barcode No:	SA471352				
Asset Status:	Register Asset	Serial No:	6209400				
Disposal Status:	Active	Depreciate Flag:	Depreciating				
Finance Flag:	Owned	Maintenance Flag:	Maintain				
Asset Type:	A35500 ALAT KELENGKAPAN FOTOGRAFI						
Product Name:	YAMAHA ANALOG MIXING CONSOLE						
Description:	YAMAHA ANALOG MIXING CONSOLE						
Details							
Location:	Jabatan Muzik, Fakulti Ekologi Manusia	Kumpulan Wang:	05				
Default Location:		PTJ Perolehan:	6209400				
Supplier:	LS MUSIC SDN BHD - Created by HC	Install Date:	26/02/2016				
Person:	A03551 AHMAD FAUDZI BIN MUSID	Condition:	<Unclassified>				
Cost Centre:	3201 FAKULTI EKOLOGI MANUSIA	Maintenance Ref:	6209400-13201-A3550				
Maintenance:		Preset Class:	Preset				
Service Level:		Last Audit Date:					
Finance							
Purchase Price:	6,320.77	Purchase Order:	000145				
Other Currency:	0.00	Purchase Date:	20/04/2016				
Maintenance Cost:	0.00	Invoice No:	IV00000119				
Current Value:	0.00	Warranty End:					
Insurance Value:	0.00	Maintenance End:					
Replacement Value:	0.00	Valuation Date:					
Est. Disposal Value:	0.00	Insurance Date:					
Disposal Value:	0.00	Replacement Date:					
Disposal Value Other:		Disposal Date:					
Disposal Reference:		Dep. Start Date:	01/01/2016				
:	0.00	Tarikh Verifikasi:					
:	0.00	:					
Current Units							
<Unclassified>		0					
Presets							
Lokasi sebenar	BILIK RAKAMAN RUMAH MUZIK 4						
Pengguna sebenar	KEGUNAAN RAKAMAN						
Grant (Dev)							
Dasar	XX						
Jumlah PO	6700						
Tarikh Invois	1/04/2016						
No. Cek							
Projek	6209400						
Akaun asal							
ID Lama							
Harga Asal							
temp 2							
GPS							
Latitude:	0.000000						
Longitude:	0.000000						
Altitude:	0						

FIGURE 1: Asset of Individual Details for University Putra Malaysia. (Scheme of the author).

Equipment which is unusable or beyond repair must be disposed of. All assets which, in the condition mentioned, must be disposed of by reference to the ISO system. All details such as, the date of purchase, purchase order number and the asset number as shown in Figure 2 must be entered into the asset management system of the University.





FIGURE 2a, b, c, and d: Details such as the date of purchase, purchase order number, and the asset number (Photographs by the author).

This refers to all equipment ranging from 9-foot Steinway, upright pianos for each practice room, baby grand pianos for two Music Houses, families of orchestral instruments, computer-aided music education systems and audio mixers, electronic keyboard, sound modules, MIDI devices, magnetic tape multi-track recorder, hard disk recorder for students of Music Technology. Acoustic instruments are not as prone to extinction as electronic musical instruments are. Most electronic instruments often become extinct when there is an enhanced version of similar applications on the market. Hence, many worn-out electronic musical devices were disposed of. Among that were the standalone hard-disk recorder, boxes of multi-track cassette tapes, and others are of the DAT and VHS tapes. There is an urgency to migrate the recorded material such as cassette tapes that come in varying forms ranging from Ferric-Oxide, to Cro2, and Metal. These carriers are warranted to be extracted and migrate onto a more stable medium, not only in general as everywhere in the world, but also since it has become the university policy that equipment's exceeding certain years will be disposed of. The selection focuses on the recorded materials that include two-track live musical performances, multitrack musical compositions, and final recording projects.

Back in the late 1980s and early 1990s, the four-track machine was one of the tools used by students to record their audio assignments and final projects. Most of the time, it is used to record and mix sound combinations where MIDI instruments could not be supported. It includes electronic music composition, harmony, and arrangement involving either a mixture of synthesizers, electric guitars, bass or acoustic instruments and vocals. What is interesting, in the rapidly growing development of audio technology, each of the tools created, and their technical design, requires specific operating techniques. From the viewpoint of signal migration for audio preservation, the discovery is about past technological advances. It is an opportunity to expose my audio students to past technologies such as the four-track system and hard disk recorder. In this paper, the focus will be on the challenges and issues about to migrate audio signals in the two formats exemplarily, the cassette tape of the 4-track recorder and the data from the virtual standalone multitrack system, its challenges its demands in the process of retrieving signals.

DEVICES SPECIFICATIONS

The FOSTEX 160 Multitracker Recorder/Mixer (Fostex Corporation, 1987: 4) was made in the year 1987 uses a single compact cassette deck. It comes with a 4-track, with 4 input modules that serve as a mixer as well as recording console. Each head comprises of 1 x 4 Track record/replay heads, and 1 x 4 Track erase head. The single DC servo motor runs at 9.5 cm per-second or runs at 3 3/4ips - twice the normal cassette speed. The machine able to encode 40Hz to 14kHz of frequency responds on Cr02 magnetic tapes (IASA-TC04 2009, 50) with signal to

noise ratio (SNR) of 70dB (Dolby C¹ noise reduction). The noise reduction (NR) mode of the FOSTEX 160 allows for the user to manage the noise down, which derived from the cassette tape without unduly damaging its sound quality. The NR is an on-off switch that allows the user to select the feature. Most of the time recording was done via multi MONO. The block diagram shown in Figure 3 is a representation of the FOSTEX 160 input and the output sections.

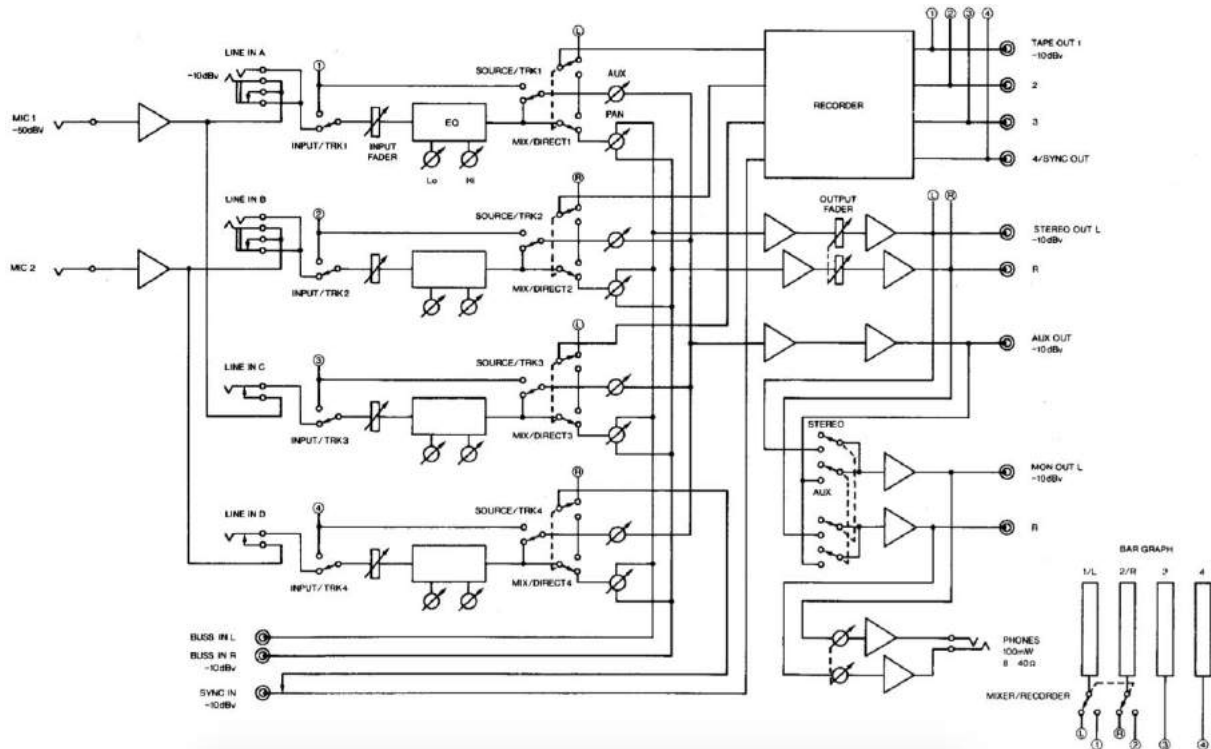

FIGURE 3: Block diagram of the FOSTEX 160 Multitracker Recorder/Mixer, a representation of the input and the output sections of the device.

The ROLAND VS1680 was made in 1993 (Roland Corporation, 1998). It enables users to record 16 tracks of digital audio recording with 16 virtual tracks. The device comes with a 24-bit (20-bit A to D and D to A converter) multitrack professional recording mode. Its quality allows for ample headroom and its dynamic range, with 10 analog audio inputs. This includes two balanced XLR-type inputs with phantom powering for condenser microphones or direct injection boxes, 6 balanced 1/4" inputs, and 1 stereo digital input (optical TOSLINK and coaxial). At the rear of the ROLAND VS1680 were 8 RCA-type outputs. This includes master auxiliary A and B and monitor outs. The device comes with built-in multi-effects independently on each channel as shown in figures 4 and 5. The front panel was its controller, and the rear was the sockets for other possible connections. This includes a direct audio CD recording, SCSI port for data backup.

¹ Dolby C-type noise reduction starts to take effect in the 100 Hz region and provides about 15 dB of noise reduction in the critical 2,000 to 10,000 Hz hiss area, around 400 Hz and 20 dB.



FIGURE 4: The front panel and its controller; Figure 5 the rear are the sockets for other possible connections (Photographs and all following photographs of the author).

METHODS

To ensure the extraction is at its optimal performance, a separate procedure is required before and during the retrieval process. The following in Figure 6 is the process flow in conducting signal extractions of two different platforms, namely the multi-track cassettes magnetic tape and the hard disk recorder.

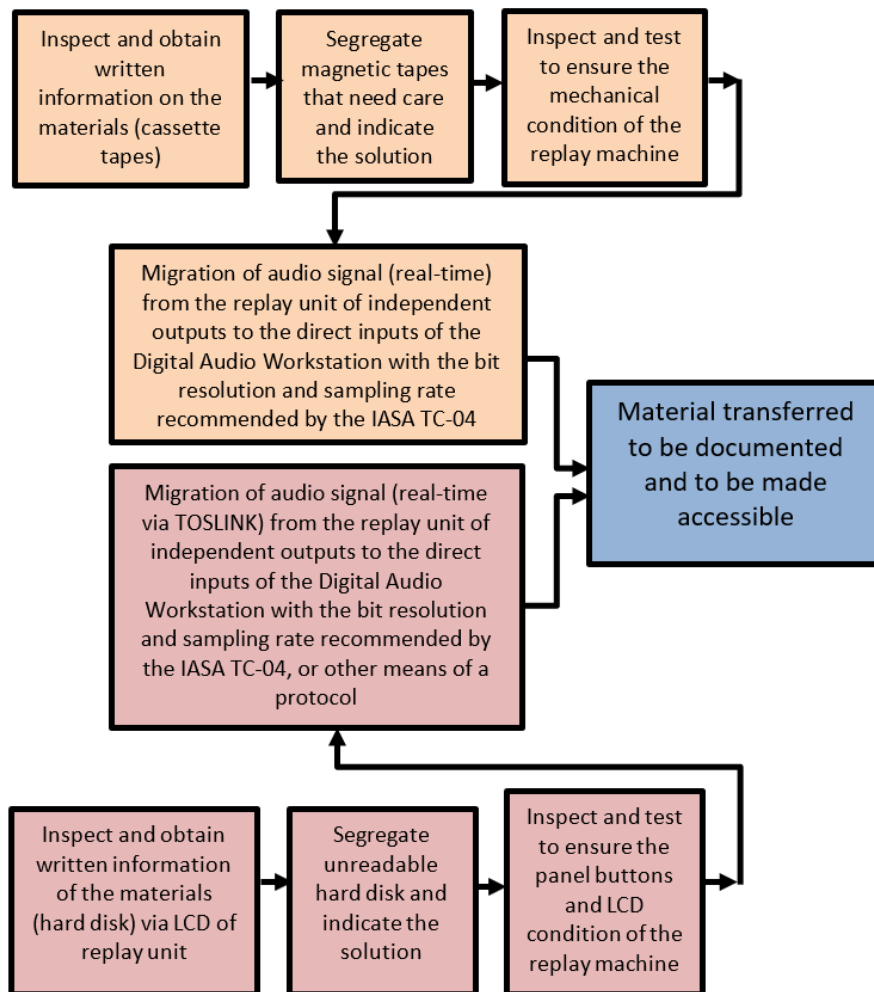

FIGURE 6: Signal extractions of two different platforms, namely the multi-track cassettes magnetic tape and the hard disk recorder replay machine (scheme and all following schemes by the author).

CHALLENGES AND DEMANDS

It is indeed unexpected things occur in the course of signal migration of the two different platforms of audio devices. However, it is possible to address the difficulties and problems related to the process according to the process flow shown in figure 6.

During the inspections, it is found that less or no information is written on the cassette tape cover. Information such as the date and year, the title of the song or piece, tape speed in which the music was recorded, tape directions either A side or B, and the number of recorded tracks used in the sessions. Others have been just the title of the music, which requires a playback for identifying the audio content within each track. Although the audio content has been identified, the tape speed raises another obstacle. However, most of the recordings contained in materials that require migration are at two speeds. That is pre-set speed or half of the pre-set speed (slower) as shown in figure 7.



FIGURE 7: Tape speed of the replay unit.

Segregate magnetic tapes that need care due to physical deterioration (fungus, brittle as the binder's lubrication is lost, sticky, broken even dirty tapes) or mechanical problems. Figure 8 and 9 is an example of the deterioration due to fungus and mechanical issue such as a missing pressure pad, or a rusted magnetic shield, to name a few.



FIGURE 8: Deterioration due to fungus; FIGURE 9a and b: Mechanical issue such as broken tapes, rusted magnetic shield.

Through inspection and assessment of the multi-track tape machine, the obvious issue were the machine operating voltages and its polarity. Since its operating voltage is at 110 volts, the FOSTEX 160 Multitracker Recorder/Mixer requires a step-down transformer. Unlike the Roland hard-disk recorder does not need any transformer, as it is already operating at 220 volts.

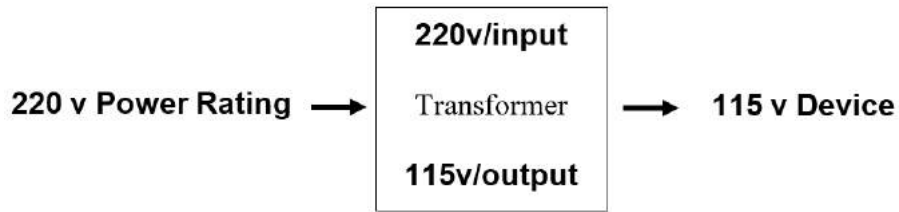

FIGURE 10: Scheme for this process.



FIGURE 11a and b: Transformer from 220 volts to 115 volts.

Another would be the mechanism such as the tape speed, functioning rewind and forward playback buttons, all faders and knobs, peak program meter for correct level monitoring, pre-set and variable speed control are in working condition. Unfortunately, it was found that tape engage and disengage from the tape head is not functioning. Hence the multi-track tape machine is to open and inspect the malfunction mechanism.



FIGURE 12a and b: The front and rear.



FIGURE 13a, b, c, and d: Four screws have to be removed, with the last being attached to grounding of the circuit board.

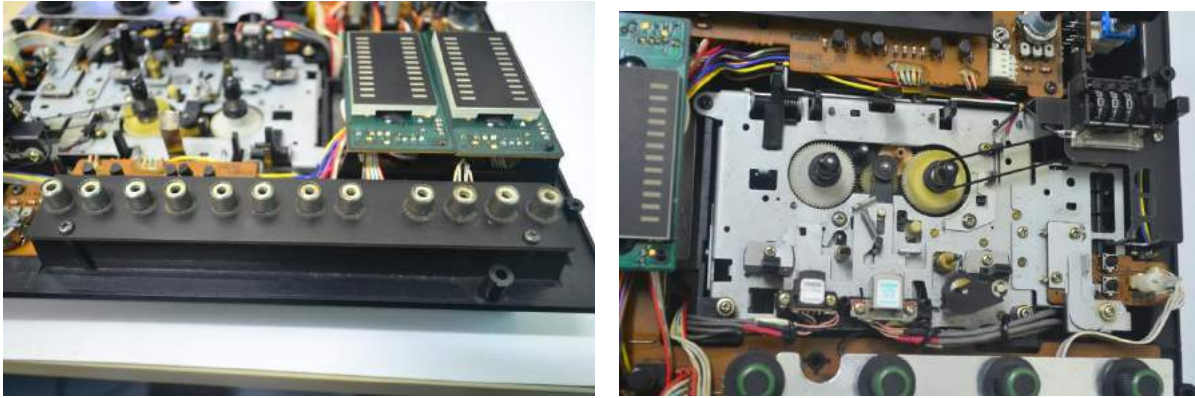

FIGURE 14: The front cover is removed, that allows for an assessment of the supply and the take up tapes.

Is to be found that the driving belt mechanism is at the back of the supply and the take up reel, dismantling the front mechanism is a challenge.

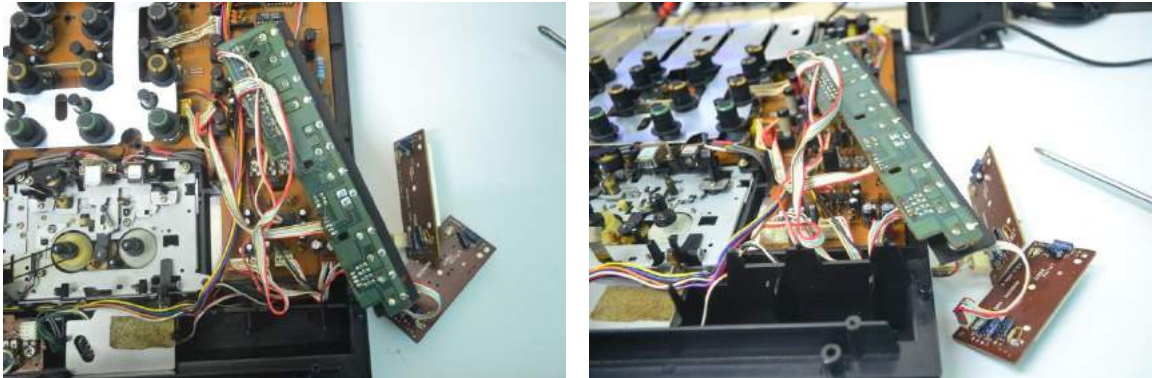

FIGURE 15: All the monitors, stereo, synchronization and the 4 direct out circuits.

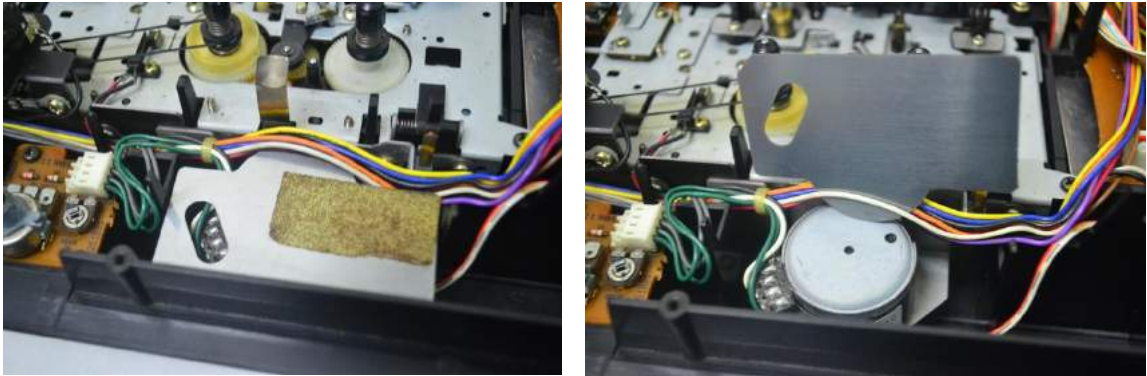

FIGURE 16: A protector of magnetic fields derived from the single DC servo motor 3 3/4ips - twice the normal cassette speed.



FIGURE 17, 18: Removal of the variable speed control switch. **FIGURE 19:** Azimuth and Zenith adjustments for clearer sound quality.

The azimuth and zenith positioning of the playback head should be at its correct position for a quality replay signal. The playback head should be clean² after 4 hours of running time. Upon the removal of the rear concealment of the multitrack machine, the cause of malfunction tape engages and disengage mechanism is due to the decay drive belt.

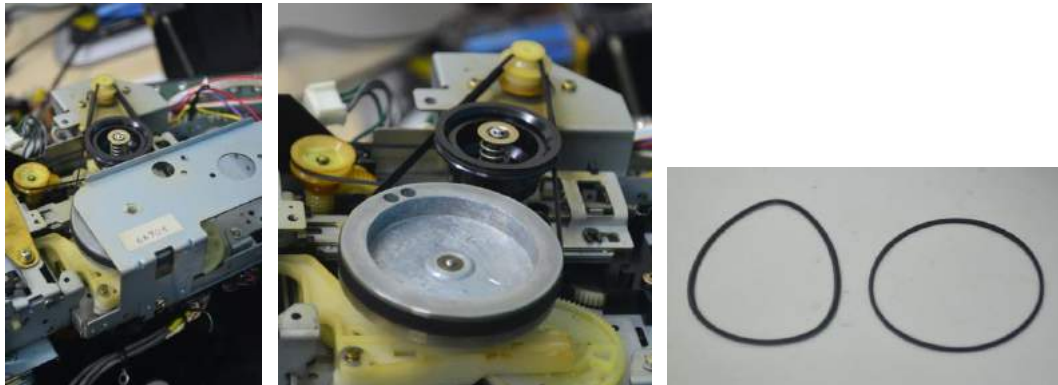

FIGURE 20: drive belt mechanism and decay tape belt might output an incorrect and unstable pitch.

A broken grounding chassis cable was found and to be fixed via soldering iron. Failed to restore the connection might yield an unwanted buzzing the overall output.

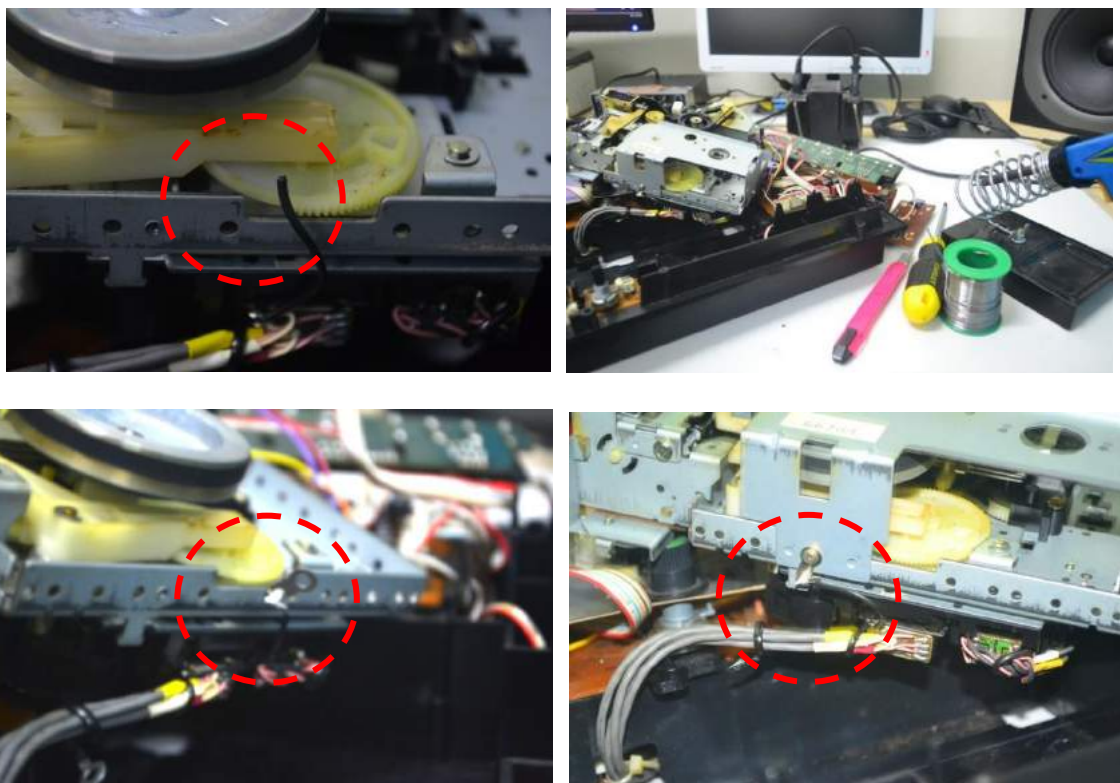

FIGURE 21a, b, c, and d: broken grounding chassis cable that required fixing.

Migration of the replay 4 track tapes direct out of the replay unit were sent in as a direct signal out, to the direct inputs of the Pro Tools via Digi design 003 audio interface at 24-bit resolutions 44.1kHz sampling rate. A 1 core 1 shield cable RCA to ¼ inch was plugin into the input of the Digi design 003 audio interfaces. It is important to understand the block diagram of devices, as

² Analogue equipment requires regular alignment to ensure that it continues to operate within the specification. It is recommended that heads and tape path must be thoroughly cleaned every 4 hours of operation, or more frequently if required, using a suitable cleaning fluid such as isopropyl alcohol on all metal parts. Rubber pinch rollers should be cleaned with dry cotton buds or with cotton buds dampened with water as necessary.

it will determine whether the migration of the audio signal has achieved its proper standard operating level. As shown in figure 22 below, all output will be at -10 dBv.

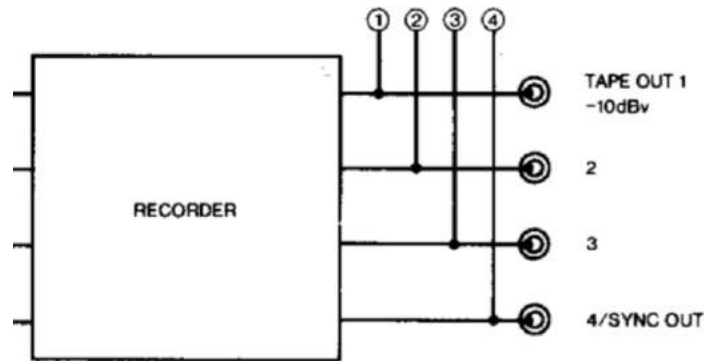

FIGURE 22: all output is at -10 dB.



FIGURE 23a and b: Direct RCA outputs – 10dBv to the inputs of audio interface independently.



FIGURE 24a and b: Migration of audio signal (real-time) from the replay unit of independent outputs to the direct inputs of the Digital Audio Workstation with the bit resolution and sampling rate recommended by the IASA-TC04.

STANDALONE HARD DISK RECORDER

The VS1680 signal migration is of the TOSLINK or analogue can be made available, provided replay unit able to playback or decode audio signal information or otherwise further steps to be carried out, particularly ways to extract the data of the VS1680. Through the inspections, it seems impossible to obtain any information from the LCD replay unit. This was because the lifetime of the liquid crystal display has just ended. Nothing can be read or retrieved from the display. Based on that, another process can be done via physically remove the hard disk.

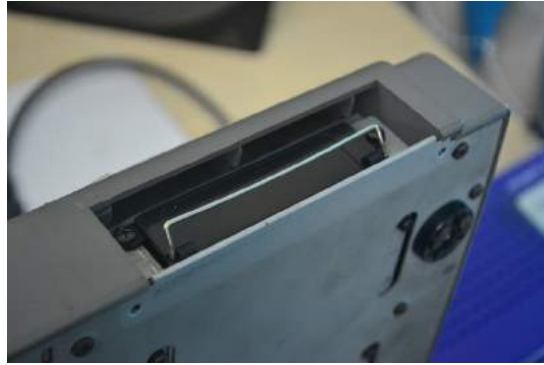

Devices and drives (6)

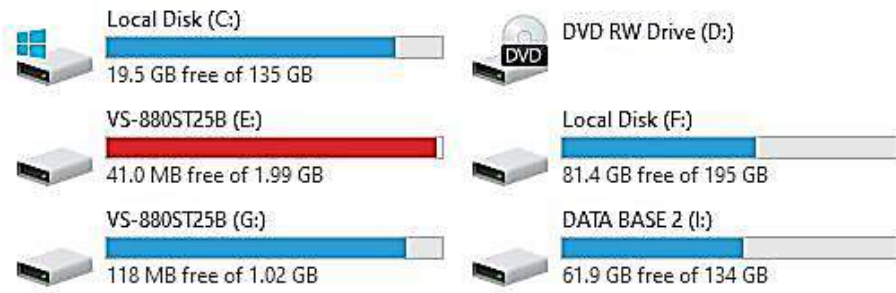

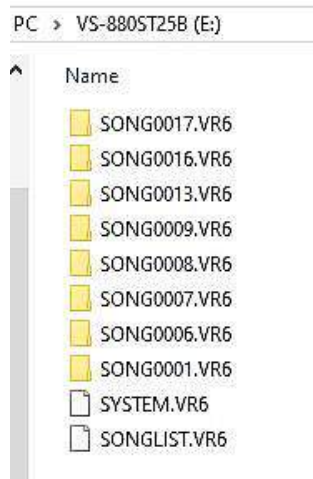

FIGURE 25 a-h: Extract via hard-disk using the IDE to USB cable to retrieve data and the resulting screens.

VR6 files were unassigned file type that requires an extension. The VirtDisk.com software seems to be the best choice as to extract and convert all the necessary per folder onto individual wave tracks that can be accessed via any DAW.

CONCLUSION

Data migration is a steadily evolving process, and each process technically is unique its way. The uniqueness derives from each and every technology that was created in the past. As an audio archivist, one should not disregard in handling such materials and its replay machine.

This study has shown that the proposed model is the notion of thinking and understanding sound in multi-dimensional ways, rather than ways proposed through conventional two-dimensional sound collections. It's not only about preserving the content, but also preserving the both the material and its replay unit as important content. Preserving content, material that holds the content, the replay unit as well as the knowledge in retrieving through past technology understanding. The archive material is not restricted to only audio-visual materials, but to other content that is tangible to be preserved. As stated by Joey Springer in her keynote address

” Many documents continue to disappear through neglect, destruction, decay, and the lack of resources that contribute to an impoverishment of the memory of mankind.” (Springer, 2014).

REFERENCES

- Bradley, Kevin, ed. 2009. *Guidelines on the Production and Preservation of Digital Audio Objects. Standards, Recommended Practices and Strategies*, IASA TC-04. Auckland Park: International Association of Sound and Audiovisual Archives (IASA).
- Standard Popular. 2008. Jabatan Standard Malaysia, Kementerian Perdagangan Antarabangsa dan Industri [Department of Standards Malaysia, Ministry of International Trade and Industry]. Accessible via <http://www.jsm.gov.my/ms/ms-iso-9001#.XbK5R44zaM8>, last accessed 25 October, 2019.
- Fostex Corporation. 1987. Owner's Manual Fostex Model 160 Recorder/Mixer. 560-3, Miyazawa-cho, Akishima, Tokyo Japan. Accessible via URL: - https://www.fostexinternational.com/docs/tech_support/manuals.shtml (Retrieved 20th October 2019)
- Musib, Ahmad Faudzi. 2015. *Contextual sound preservation of selected local string instruments*. PhD thesis, Universiti Putra Malaysia.
- Roland Corporation. 1998. Owner's manual 24-bit Digital Studio Workstation Roland VS1680 - 2036-1 Nakagawa, Hosoe-cho, Kita-ku, Hamamatsu, Shizuoka 431-1304, Japan. Accessible via URL: https://static.roland.com/assets/media/pdf/VS-1680_OM.pdf, las accessed 26 October, 2019.
- Schuursma Rolf. 2010. *Problems of selection in research sound archives: IASA Special Publication No.5*. International Association of Sound and Audiovisual Archives (IASA).
- Schuursma Rolf. 1981. IASA with the International Association of Music Libraries, Archives and Documentation Centers Conference in Budapest, Hungary. Unpublished ms.
- Springer, Joie. 2014. *Preserving Audio-visual Documents: An International Perspective*. Keynote address at the 18th SEAPAVAA Conference, Vientiane, Laos, 26-30 May 2014.

SAFEGUARDING STRATEGIES OF SOUND ARCHIVES AND ITS MEANING TO THE PACIFIC REGION

Gisa Jähnichen

Shanghai Conservatory of Music, contact: gisajaehnicen@web.de

Abstract

Sound archives and connected visual archives are all the time challenged by a speedy deselection of items that follow daily demands of decision making according to cultural policies and economic necessities. These challenges are imposed upon specific archival materials of a value yet incomprehensible to our recent level of knowledge. Since we are not able to fully understand all dimensions of collected materials which is often accumulated to serve single publications or written qualifications, their contents are in many ways inaccessible, not only physically or digitally.

My paper in this regard is based on experiences with small scale archives in Asia situated in universities and research institutions, which do store rich collections on analogue carriers or as digital files yet do often not follow up with maintenance and quality control in terms of accessibility. A paradigm shift towards a better understanding of the maintenance and quality matter is seemingly the only way out in order to keep those items of which importance for future uses is not guaranteed. The consequence of these thoughts can lead to strategic suggestions that can be applied to many cases, especially in a region with permanent environmental and social tournaments such as the Pacific Region.

Keywords

Sound archiving, Pacific region, Digital knowledge, Regional features, Strategies

BASIC QUESTIONS

Safeguarding is an interesting concept that has to be scrutinized in its details before being brought into the context of this paper. If someone is going to safeguard something, then this act implies that there is something of a specific value and of a weak nature at the same time. The questions arising are the following:

- What makes something having a specific value, to whom, and in which time/space relationship?
- Why is it weak and has to be safeguarded, by whom, and in which time/space relationship?

Instruction material on audiovisual archiving (Edmondson 2016 [1990]) gives good examples, why audiovisual archivists should be neutral in making decisions on the selection and deselection of items they want to care for. This principle is still valid and right, yet it should be modified. Learning from history, from the thousands of libraries, archives, treasure magazines, storage officers, there was always and will always be a selection and deselection policy. Everything done in an archive is adhering to a policy, whether it is wanted or unwanted to the individuals who are involved. Human beings change their views on values as often as they change their living purposes, their approaches to daily tasks, their own “strategies” in overcoming difficulties. Thus, safeguarding strategies of anything valuable will change along with these changes.

The Pacific Region is insofar quite special since those strategies for succeeding in survival through steady renewal, quick responses to challenges, appropriating any kind of model, and restless search for better solutions, were faster changing than elsewhere. Also, these changes impacted the life of many formerly isolated communities in a global context that seemed overwhelming at the beginning, and burdening at current times. Safeguarding of sound archives is just a small yet very sensitive part of it.

With all the social and cultural changes experienced, we may have to rethink the following:

1. How does a safeguarding strategy can be made fit the environmental development at current times and in the nearer future?
2. What are the specific challenges regarding the modification of selection and deselection policies in this context?
3. What might be the outcomes of our current behaviour?
4. Can we afford to still wait for better technology, being understaffed, not acknowledged, insignificant in comparison with other production modes?

BASIC ANSWERS

Let me answer these questions step by step as well as I can.

1. In order to keep the efforts in safeguarding increasingly under control, we may have to change our approach to collecting. Meaning, we may not be able to collect everything regardless of contents. This will request a new scrutiny carried out by those people who decide about selective criteria: We have to better choose what to keep and what not. It may be of little help to store lessons, for example, that will never be looked at again since most of the students already did not look at the original presentation. Another solution could be to make recordings on demand only and to shift responsibilities of processing and metadata delivery to the users. This would – at least – allow for a better overview on demands and shortcomings in the field of diverse actions such as teaching, exhibiting, illustrating in a wider context of public media, or research. Items that are less asked for, would be automatically less often recorded, stored, processed. If we compare with other environmental issues, we can easily observe that creating less waste comes to a better understanding of waste and necessary substance. This could also be applied to sound items.

For example: field recordings in a traditional understanding of hard-core ethnomusicologists are those rare recordings done in remote areas of creative people in their usual surroundings who would never choose to travel far away in order to deliver their skills. Many of them may not be aware of their rare skills or the value they can create.

Nowadays, I feel it to a certain extent imposing and patronizing if some ethnomusicologists demand recordings of sound and skills, buying clothes produced and crafts practiced in remote areas in order to safeguard a living style of people whose vision is to change their living style in response to a modernity that is brought to them, last but not least, along the same path visitors, among them these ethnomusicologists, are coming and going.

I suggest creating a better co-operative atmosphere and a space of freedom of choices in order to create multiple possibilities to represent the past and to keep the knowledge

about any creative skills, among them sound production. The way, people might be represented will also have to change, so do archives, recordings, and metadata. The most effective way to respond to current changes that took place throughout history, to let the most active agents decide about necessities. The choice should be always with the creative people that are partners on the same level. Following this, there will be not created too many things that will not be used at a later time.

2. Avoiding recording trash, waste, or unused items (whatever term we may choose) is a core idea in this regard. I think that we may empower a lot of people to collect their own valuable sounds and then to manage a better way of safeguarding these recordings. This has to include an empowering of freedom of choice. The guidance and the new policy may have to accept diverse perspectives and multiple purposes. Learning from the past, archivists or curators may not be anymore in the position to choose what they like – or to say it more precisely – are under pressure to learn and explore this way of freedom of choice as part of their lifelong updating. While authenticity and the so-called real thing were a long time at the heart of sound collectors, the understanding may have to shift to viewpoints that are beyond this narrow screening. It happens often that skills recorded are sorted according to their capability of being exhibited on a stage, in a program, at an event or the like. These marketable features may have to be shifted and set beside a meaningful dealing with sound creativity. It is no longer an abuse of traditions to recreate them or to fragment them, yet researchers may need an option to retain access to historical shapes. So, there will be many different options dealing with this kind of recordings and all will have to follow a policy of selection and deselection that is built up through algorithms of use and impact. Policies will change far more often than in the past and options to be kept will be delivered by using space and time of previously over-collected areas such as redundant recordings of media events or repeatedly given lectures.
3. The outcome of our current behaviour might be that we will sit for a long time on a huge amount of sound recordings, that we willingly create low quality sound recordings in order to serve visual requests, that we still hesitate to learn to co-operate and to understand that giving these recordings to professional institutions with the capacity to transform them into useful items in the digital world means getting them back and that we do not feel the organised loss of every day waiting for things to happen. Yes. I think that waiting for better times, other decisions, brightest leaders, staff, resources, money, projects, is the dead of many sound recordings that would not fall under the category “trash”. So, my personal view is that we should not wait, we should act. Now. Here. Everywhere.
4. I am sure, that technology will surprise us all with new ideas. Yet, I also know from experience that a surprising technology comes from surprising visions and a high demand for problem solving. It is not just a playground of audio engineers who find some tricks and magic spells. Technology must be challenged and people have to demand better solutions. For this, archivists have to steadily learn and adapt to fast changing requests. I am also sure that the focus on marketability will fade sooner or later. The focus may shift into supporting specific human skills, communicating of complex structures and thinking that cannot be expressed by other means. The potential of sound as a tool for orientation, movement patterns, local habits, an adaptation of moods and emotions to changes in daily life might be not yet fully explored. While writing this, I know that there are surely many other colleagues writing similar things like me, thinking in a similar way or doing even more in order to find these capabilities. If we see how much knowledge could be saved through historical sound recordings, we

can only roughly guess how much potential we do not know yet and is inherently saved by what we create today.

Now, setting these observations into a context of the Pacific Region means to understand its specific geography of sound, people who create the sound, people who safeguard, and who will use these safeguarded sounds in the future.

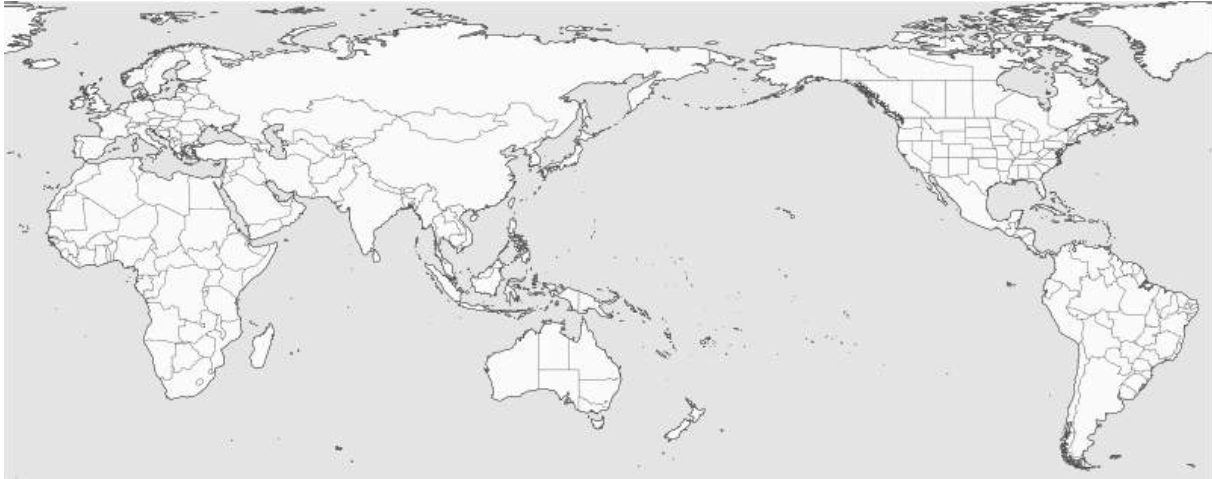

FIGURE 1: Map scheme centred on the territory of the Pacific Region (Public domain by WMC).

The Pacific Region is often considered an empty area. So was Europe during the high time of the Roman Empire. And America before the arrival of strangers. We know that these were wrong pictures and we should be well aware of how wrong this picture of an empty Pacific region might be.

Studying the Pacific Region, one may be taught the following

“The study of the Pacific Islands helps us to see the impact that isolation, scarcity of resources and land, small populations, limited economic opportunities, and social/ political dysfunction, and colonialism can have on a region.”¹

CONCLUSION

The Pacific region consists of still very isolated communities (30 000 islands), naturally surrounded by water and far from each other. Yet the Pacific Region could be also seen as an expert area of networking and task sharing since these are skills of utmost importance in such a region. Though many places are isolated, the inhabitants are mixed and carry cultural features of a number of groups of people settling in or moving through the area. This is not seen as a weakness, but a strength. Looking through this gaze, the Pacific Region is in many ways an excellent model in order to capture future demands, the will of keeping peace, independence, yet well working co-operation, developing yet trusting in traditional patterns of life as well. Colonial times left traces that are irreparable and caused a destroyed balance of power structures, natural resources, and social development issues. However, it is a fact of history that cannot be made undone, so, all we can do, is taking better care of the future and working towards recreating a meaningful society and continuing development of better equipped people who can make use of their freedom of choice in all matters. What will rapidly change in the future?

¹ This is teaching material made available by Sara Cederstrand on 23 May, 2001, http://maps.unomaha.edu/Peterson/geog1000/Notes/Notes_Exam3/Pacific.html, last accessed on 21 October, 2019. Used material Clawson (2001), DeBlij & Muller (2000), Haub & Cornelius (2000).

There will be no higher demand in population density. The number of people living in an area is provenly no guarantee of success. There will be less work that demands biological fitness of the human body, which calls for balancing activities of which the performing arts might be an important part. There will be widely access to any type of knowledge, so that monopolizing knowledge will not lead to more power. This may impact the way of how this availability is used and managed. Professionals will have to focus on more than one specialization, students may have to study more than one time or a wider spectrum of skills. These features may also apply to many other societies around the globe. In the Pacific Region they might be more clearly visible first. The huge ocean, a resource yet to be explored in all its depths, sound included, is possibly a place of the future not only for people already living in the area. We do not know yet, how this will look like, but we may understand the vision. Dreaming of the Southern Sea is not a dream anymore.

Safeguarding strategies in the Pacific Region are, therefore, a very hot topic. It is so significant for the human survival that we are not even able to understand the topic's importance to the full extent. For this and many other reasons I am curious about everything that brings us closer to an understanding of future visions and to the insight that we have to act without further delay.

Finally, I want you to hear what Ray Edmondson (2014) had to say about it. He says that being an audiovisual archivist is not simply a job but it is a calling. It only comes with sacrifices and it has only been successful when these sacrifices are not the centre of attention. Ray Edmondson from Canberra was one of the driving teachers in my life. He encouraged me in many ways to deal with archives, with staff, with students, with regional preferences. He, as well as Dietrich Schüller, were not only great mentors, they are still friends I can count on. And I think that we all have some recordings, events, or key persons in life, we count on.

REFERENCES

- Cederstand, Sara. 2001. Teaching Material on Pacific Region. Made online available on 23 May. http://maps.unomaha.edu/Peterson/geog1000/Notes/Notes_Exam3/Pacific.html, last accessed on 21 October, 2019.
- Clawson, David L. 2001. *World Regional Geography: A Developmental Approach*, 7th Ed. Upper Saddle River: Prentice Hall.
- DeBlij, H.J. and Peter O. Muller. 2000. *Regions and Concepts*. New York: John Wiley and Sons.
- Edmondson, Ray. 2016 [1990]. *AV-Archiving. Philosophy and Principles*. Paris: UNESCO.
- Edmondson, Ray. 2014. *Video Interview for UC Alumni Network*. Canberra: University of Canberra Press.
- Haub, Carl and Diana Cornelius. 2000. *World Population Data Sheet*. Washington: Population Reference Bureau.

EXAMINING UNINTENTIONALITY AND INTENTIONALITY OF SOUND IN PREHISTORIC MALTA

Juan Sebastian Correa

University of Malta, contact: juan.s.correa@hotmail.com

Abstract

This paper attempts to give an idea of the sonorous past of prehistoric Malta by presenting possible soundscape scenarios. It validates the importance of sound as auditory experience, because this was crucial in the history of humanity, while it attempts to trace the beginnings of organised sound.

This research is to introduce a number of findings that are connected to sound perception and distribution among the inhabitants of Malta. Specific emphasis is given to discussions of whether these sounds were essentially intentional or not. By going through the collected facts about the introduced findings, there are overlaps in functions and sound tools that indicate an early cultivation of music. In protecting the related findings, some of these early attempts can be hopefully reconstructed in the future.

Keywords

Malta, Prehistory, Sound Production, Soundscapes, Idiophones

It goes without saying that prehistoric man was surrounded by sounds from different sources. Such sounds were either a product of the immediate environment (such as the sounds of nature) or man-made ones. In other words, we can say that prehistoric man was surrounded by unintentional and intentional sounds. The relevance of this study lies in the fact that music is made out of intentional sounds and that arbitrary sounds only become music when these are organised by humans. Although the existence of music in prehistoric Malta cannot be ascertained, such prehistoric society experienced a number of processes related to organisations which are evident in their art and architecture. It could be argued that such processes imply an organisation of arbitrary sounds of which unfortunately we have no direct evidence.

UNINTENTIONAL SOUNDS

The Maltese Archipelago is made up of three islands: Malta, Gozo, and Comino. An island is literally a piece of land surrounded by water. It is evident that the sound of water predominates as a result of the islands' geography. A place surrounded by water is comparable to a mother's womb, a place in which life begins. The testimony left by the early societies which inhabited the islands, mainly in the form of artistic and abstract representations, attests that those societies venerated all things, such as the land, the air, fire, and animals.

Early man was captivated by the sounds of nature, such as the wind, the sea, the echo effect in natural caves, the crackle of fire, and so on. Like us, he made sense of the world that surrounded him. As an animal symbolicum (Viik, 2011: 103), he explored and conferred meaning on the environment in accordance with his own experiences (Gibson, 1986). Then he realised that some sounds are not mere sounds, but meaningful sounds. The sense of hearing, that is, the act of listening, discloses information vis-à-vis external phenomena and data in the form of sound (Carter 2004). Thus, sound is an integral component of the ways in which people interact with the surrounding environment. Human history is marked by a constant struggle for survival,

wherein auditory experiences play an important role. For example, by attributing meaning to sounds, our ancestors recognised that these could signify danger (Scarre and Lawson, 2006). In Malta, early hunter-gatherer groups may have categorised and reproduced sound phenomena through sound mimesis or devices which serve as calls for animals and birds during hunting. The practice of using sound devices to attract animals is still ongoing in Malta. Devices known as *sfafar tal-pluvieri* or plover whistles are used to imitate bird calls and entice them towards a trap (Zahra, 2006; Figure 1).

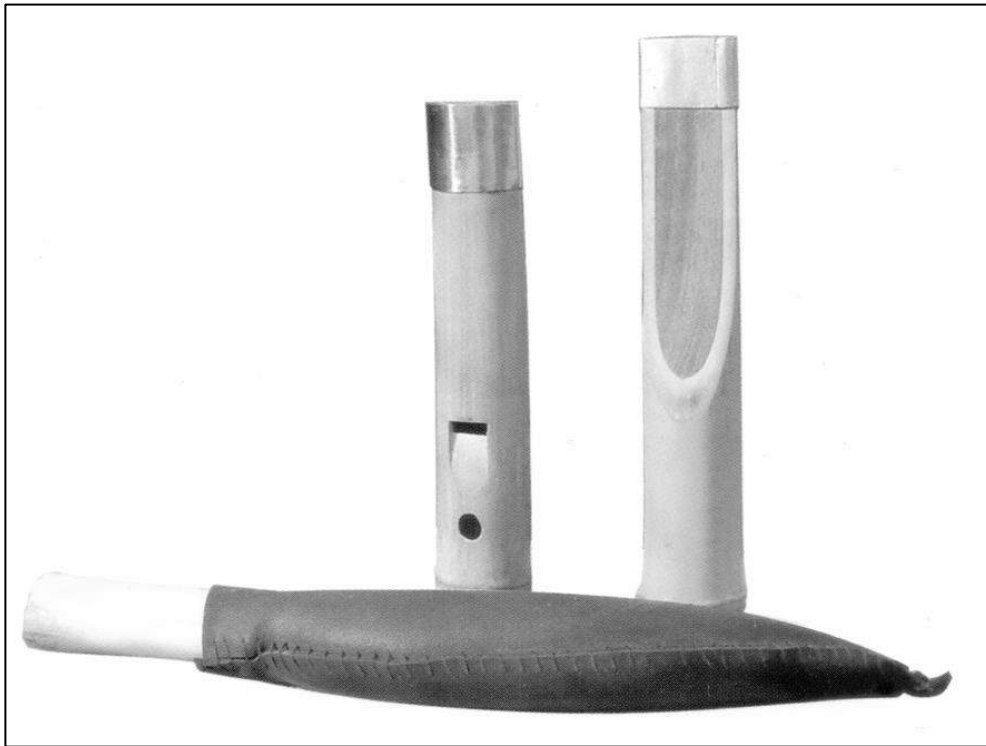

FIGURE 1: Sfafar tal-Pluvieri, a Maltese hunting whistle or bird call (photograph reproduced by courtesy of Ruben Zahra).

Maltese prehistory began with the archipelago's colonisation, probably by farming groups from nearby Sicily in 5200 BC. Such early farming communities were evidently surrounded by unintentional and intentional sounds. Sounds of nature were part of the unintentional soundscape while the sounds of human voices, stone tools, and other devices were part of the intentional soundscape. Stone tools, in particular, may have been used as sound producing devices. Tool making itself involves a wide range of processes related to organisation and music. Whether there was music in prehistoric Malta is not clear, however, the production of artefacts, such as hand-axes or scrapers, attests that there was a conceptual thought associated with the production of these objects. This idea can be extended to validate the concept of production of objects that produce sound. Here, I am referring to objects that might or might not be manufactured with the aim of producing sound, yet nevertheless do produce sound.

'Environmental sounds influence the ways in which a society responds to the world, whether in terms of navigation, mimicry, memory, language or music' (Watson 2001: 180). The first settlers of the Maltese archipelago responded in terms of navigation therefore establishing contact with neighbouring lands (Bonanno 2000). Malta was connected through uninterrupted seafaring activity during the Neolithic period and this facilitated trade (Bonanno 2008). Maltese prehistoric man imported valuable materials, such as greenstone from the Italian mainland as well as flint and obsidian from the islands of Sicily, Lipari, and Pantelleria (Skeates 2010). These were imported as cores to be processed onsite by knapping. This process involves

repetitive movements and percussive strokes, which can be associated with music practices. Knapping is a pre-conceptualised and systematic skill. Perhaps, the knowledge in relation to this technique was attained by early man through auditory experiences. Consequently, we can say that the sound was a contributing factor in tool making. This is very likely since sound cannot be omitted from the whole process. The process of knapping requires constant awareness of the sound that the stone produces as it is struck, variations in sound provide clues as to where and how hard the stone is to be next struck.

It is very difficult to attest the existence of large lithophones or rock gongs in Prehistoric Malta. The problem arises when trying to assess damage to the stone. Evidently, the action of repetitive beating on stone leaves indentations which could possibly also be the result of natural processes such as weathering. Intentional modifications, on the other hand, are more promising in that they can be associated with the aim of producing different pitches from different sized stones. Usually, these stones are flaked and shaped in a particular manner. Nevertheless, one can never categorically establish if their original function was in fact to produce a particular sound. However, we can assume that early Maltese inhabitants struck stones in order to produce some sort of sound.

The term idiophonic is used to denote musical instruments in which the material itself produces sound (Abrashev and Gadjev, 2006). However, it is also used for objects that played a double role in prehistoric Malta, such as jewellery. Personal ornaments, such as perforated hand-axes, shells, and bones were used for social display as well as sound producing devices, because these objects unintentionally produce sound through the movement of the individual who wears it. Idiophonic jewellery are all those objects whose design and structure permits the production of sound, especially, hanging perforated objects. A discovery was made at the Brochtorff Circle in Xagħra on Gozo, more specifically, in an area known as the central shrine or sacristy. The discovery consisted of an intact female body, namely, torso, pelvis, arms, and a head bearing a cowrie-shell headdress (Malone et al, 2009). Other substantial evidence was also collected from the same site. This included shells, stones, and bone pendants, beads and 'V'-perforated buttons (Figure 2). All this suggests that early Maltese inhabitants wore idiophonic jewellery.





FIGURE 2: (Above) Idiophonic jewellery from Brochtorff Circle, Xaghra, Gozo (3400- 2500 BC). (Below) stone pendants (Courtesy Gozo Museum of Archaeology, photographs by the author).

INTENTIONAL SOUNDS

Human activities are multi-sensual scenarios (Watson, 2001). In other words, any activity that is undertaken involves a number of senses. The activity of pounding, crushing, and grinding foods was practiced in prehistoric Malta. A number of saddle querns, mortars, and hand mills for grinding corn and other seeds were found at the Tarxien temples (3400-2500 BC) (Zammit, 1930; Figure 4). The rhythm of the grindstone as it moves back and forth, produces a sound comparable to a musician playing a scraper. When processing foods, some contemporary agropastoral communities, such as the Dassanach people in Ethiopia, still make use of stone querns; moreover, they perform the task in the ancient fashion.

A considerable number of sling stones were found in the immediate vicinity of the Hal Saflieni Hypogeum (Zammit, 1930: 83) (Figure 6). These implements were used to hunt down wild animals. The stone was put in the pouch section of the sling, which, when thrown, would free the stone and hit the target. The spinning motion of a sling stone produces vibrations in the air. In other words, sound is produced when the player whirls a stone through the air. This fact could not have passed unnoticed by early Maltese inhabitants. Probably, they also realised that the speed of rotation and length of the string affect volume and pitch. Perforated objects were potentially used as whirling objects or bull-roarers.



FIGURE 3: Saddle querns from Tarxien Temples (Figure reproduced from Zammit, 1930, Plate XXIII).

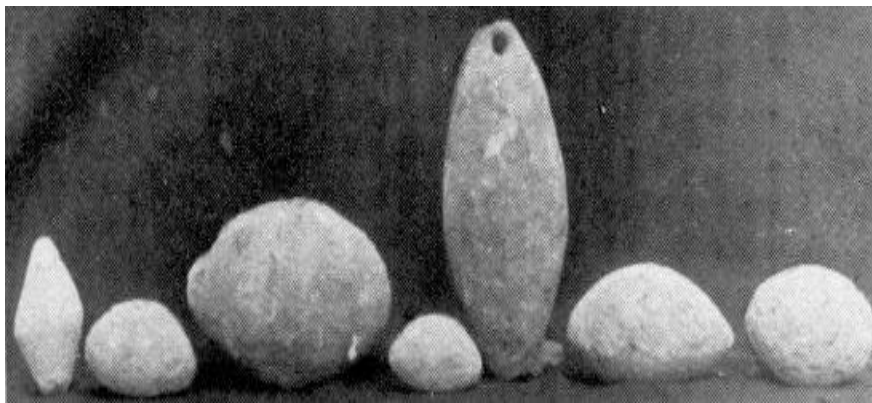

FIGURE 4: Sling-stones (Figure reproduced from Zammit, 1930, Plate XXIII).

Prior to stone tools early man used simple technologies, such as wooden sticks, bones, and other unmodified resources. These implements consisted of organic materials hence they left no trace at all in the archaeological record (Toth and Schick, 2005). As in contemporary societies, a pair of wooden sticks served the same functionality in the past, in other words, these were used as struck idiophones. This category of musical instruments is archaic so it can be traced to prehistoric times. In some societies, struck idiophones are improvised implements having no value at all and are simply discarded after use. These musical instruments are normally made out of readily available materials, such as wood, bamboo, cane, stone or bone. Sound is produced when both pieces are hit against each other, or against the ground. In the Maltese archipelago, prehistoric man found a wide range of readily available materials which can be categorised into organics and inorganics. The former category disintegrates quickly in some environments while the second is normally preserved in the archaeological record. In a Maltese prehistoric context, organic materials such as cane, bone, horn, and animal teeth were used for diverse purposes. Sound producing devices, such as struck idiophones could certainly have been made from organic materials. Perhaps a pair of sticks served to pound the ground and thus produced rhythmic sounds. In addition, they could have served to mark the beat or tempo of a dance, as well as a tool, support or wand (Rault, 2000). Rhythm sticks may have been hollowed out and served as resonators. In the Maltese archaeological record, animal bones are abundant. For instance, numerous cow toe bones were found with their proximal faces ground smooth

(Trump 2008: 43). These bones, no less than twenty, originate from Skorba (4500- 4100 BC) and were conveniently shaped to stand upright. However, they also fit well in the hands. This fact leads one to believe that perhaps these bones might have been designed to serve as concussion idiophones, that is, hand clappers. Furthermore, these artefacts allude to the period in which pre-instrumental music and practices, such as stamping, hand-clapping and body slapping were complemented by the sounds of these innovatory devices.

Most of the traditional instruments used in Maltese folk music, such as the Żaqq (bagpipe), Żummara (reedpipe), and Fleiguta (flute) are manufactured from organic materials but it is not possible to trace their entire history. Without hard evidence we are bound to make assumptions only. However, there is always the possibility that some traces of prehistoric sound tools could have survived in the oral tradition.

CONCLUSION

Hopefully the preceding paper has provided some indication that early Maltese inhabitants developed a number of activities related to music. Prehistory is undoubtedly a period which substantially differs from our own and, as a consequence, it is not an easy task to ascribe function to prehistoric artefacts. It is futile to impose contemporary thinking and practices on a historical context such as prehistory. The archaeological record, however, provides a considerable amount of evidence of intentionality of sound, that is, of artefacts that could have played a double role in the past. For example, domestic utensils, such as stone tools could have served as stone clappers. This notion evidently can be substantiated with ethnographic evidence from contemporary hunter-gatherer societies which provide a wide range of music related behaviours different to our own, facilitating our understanding of unintentionality and intentionality of sound, as well as suggesting new interpretations of the past.

REFERENCES

- Abrashev, Bozhidar and Vladimir Gadjev. 2006. *The Illustrated Encyclopedia of Musical Instruments: From all Eras and Regions of the World*. Königswinter: Könenmann.
- Bonanno, Anthony. 2000. 'Early Colonisation of the Maltese Islands: the Status Questionis.' In *Colonización Humana en Ambientes Insulares: Interacción con el Medio y Adaptación Cultural*, edited by Víctor M. Guerrero and Simó Gornés, 323-338. Palma: Universitat de les Illes Balears.
- Bonanno, Anthony. 2008. Insularity and Isolation: Malta and Sicily in Prehistory. *Malta in the Hybleans, the Hybleans in Malta*, edited by Anthony Bonanno and Pietro Militello, 27-37. Palermo: www.progettokasa.net (last accessed 15 April 2015).
- Carter, Paul. 2004. Ambiguous Traces, Mishearing and Auditory Space. *Hearing Cultures: Essays on Sound, Listening and Modernity*, edited by Veit Erlmann, 43-63. Oxford and New York: Berg.
- Correa Caceres, Juan Sebastian. 2015. 'Beyond Artefacts: Music in Prehistoric Malta.' Unpublished master's thesis. La Valetta: University of Malta.
- Gibson, James J. 1979/1986. *The Ecological Approach to Visual Perception*. Hillsdale: Lawrence Erlbaum Associates.
- Malone, Caroline, Stoddart, Simon, Bonanno, Anthony, and David Trump, eds. 2009. *Mortuary Customs in Prehistoric Malta: Excavations at the Brochtorff Circle at Xagħra (1987-94)*. Cambridge: University of Cambridge, McDonald Institute for Archaeological Research.
- Pace, Anthony. 1996. *Maltese Prehistoric Art 5000-2500 BC*. Malta: Patrimonju Publishing Limited.

- Rault, Lucie. 2000. *Musical Instruments: Craftsmanship and Traditions from Prehistory to the Present*. Paris, London and New York: Editions de la Martinière, Thames & Hudson and Harry N. Abrams.
- Scarre, Chris and Graeme Lawson, eds. 2006. *Archaeoacoustics*. Cambridge: McDonald Institute for Archaeological Research.
- Skeates, Robin. 2010. *An Archaeology of the Senses: Prehistoric Malta*. Oxford and New York: Oxford University Press Inc.
- Toth, Nicholas, and Kathy Schick. 2005. African Origins. *The Human Past, World Prehistory & The Development of Human Societies*. Edited by Chris Scarre. London: Thames & Hudson, 46-83.
- Viik, Tõnu. 2011. 'Human Spaciality: A Cultural Phenomenology of Landscapes and Places.' *Problemos / Problems* 79:103-114.
- Watson, Aaron. 2001. The Sounds of Transformation: Acoustics, Monuments and Ritual in the British Neolithic. *The Archaeology of Shamanism*. Edited by Neil Price. London and New York: Routledge, 178-192.
- Zahra, Ruben. 2006. *A Guide to Maltese Folk Music*. Edited by Steve Borg. Malta: PBS-Malta & Soundscapes.
- Zammit, Themistocles. 1930. *Prehistoric Malta: The Tarxien Temples*. Oxford: Oxford University Press.

THE SOUND OF RECONCILIATION? MUSICAL AND SOCIOCULTURAL HARMONY IN THE SRI LANKA NORWAY MUSIC COOPERATION (2009-2018)

Solveig Korum

University of Agder (Norway), Faculty of Fine Arts, contact: sk@kulturtanken.no

Abstract

This article presents findings from the Sri Lanka Norway Music Cooperation (SLNMC, 2009-2018) launched immediately after a twenty-four year long civil war in Sri Lanka. The project responded to a stated need of rebuilding a fractured society and re-establishing relations between Sinhala and Tamil populations of the island. The SLNMC comprised school concerts and public concerts, music education, heritage documentation and digitalization, in addition to skill training for musicians and technicians, festival organizers and other actors in cultural life.

The article offers a critical phenomenological approach to the concept of *harmony*, where both phenomena of musical and socio-cultural harmony are displayed and discussed in relation to each other. I set out to investigate whether harmony in the SLNMC was a taken for granted, 'dead metaphor' or an actual creative and impactful tool for implementing musical activities in a post-war context. Theoretically, my point of departure is Howell's conceptual investigation of harmony in multicultural musical projects (Howell, 2018) and specifically in the South-Asia context (Howell, 2019). I have combined elements from her framework with Sykes (2011 and 2018a) as well as insights from my own research data to present a schema of three musical and three socio-cultural definitions of harmony paired and discussed in relation to each other. In conclusion, I argue that attention to various types of musical and socio-cultural harmony can cast new light on existing art for reconciliation-practices as well as generate fresh and fertile views on how to conceive, implement and assess such initiatives in the future.

Keywords

Sociocultural processes, Harmony, Sound, Sri Lanka, Reconciliation

According to Lakoff & Johnson ([1980] 2003), metaphors are neither merely illustrative, nor purely poetic ways of designating a phenomenon, but they have materialistic consequences and are of key importance when we try to make sense and acting in the world. 'Harmony' is one such concept, frequently employed to illustrate how the world is supposed to be. Originating from the musical field, the metaphor is commonly – and often uncritically – claimed to designate ideal relationships in the sociocultural realms. It is frequently connected to a multiculturalist conception of unity in diversity, of respect and acceptance of cultural differences in society.

In this article, I critically explore how the metaphor of 'harmony' has played out in the Sri Lanka- Norway Music cooperation (2009-2018, hereafter SLNMC). Launched immediately after a twenty-four year long civil war in Sri Lanka, this development-funded project responded to a stated need of rebuilding a fractured society and re-establishing relations between the majority Sinhala and minority Tamil ethnic groups who had fought for decades. The study offers a critical phenomenological approach to the concept of harmony, where both phenomena of musical and socio-cultural harmony are displayed and discussed in relation to each other.

I set out to investigate whether harmony in the SLNMC was a taken for granted, 'dead metaphor' or an actual creative and impactful tool for implementing musical activities in a post-war context. I have divided my findings into six categories, namely three musical and three socio-cultural notions of harmony, with pairs corresponding to each other. I argue that attention

to various types of musical and socio-cultural harmony can cast new light on existing art for reconciliation-practices (such as the SLNMC) as well as generate fresh and fertile views on how to conceive, implement and assess such initiatives in the future.

Before unpacking the metaphor and sharing my analysis, I start by giving some basic information about the SLNMC. Secondly, I present my research profile and methodological reflections prior to an overview of relevant literature crossing the disciplinary fields of musicology, applied ethnomusicology and sociology that I have used in the conduct of this study.

ABOUT THE SRI LANKA NORWAY MUSIC COOPERATION

In 1983, the Liberation Tigers of Tamil Eelam (LTTE), a Tamil militant organization, waged a secessionist nationalist insurgency to create an independent state of Tamil Eelam in the north and east of Sri Lanka. This claim led to a civil war that lasted until May 2009, when the LTTE was eventually defeated by the Sinhala military during the presidency of Mahinda Rajapaksa (Sorbo, Goodhand, and Klem 2011). UN has stated that between 80.000 to 100.000 people died in what is one of Asia's longest modern wars (Charbonneau 2009). Immediately after the end of conflict, the international community poured in development funding to the island. Donations mainly went to rebuilding of physical infrastructure and basic services to the population, but also aimed to support social and religious reconciliation between the previous belligerents. Between 2009 and 2018, through several successive project periods, the Norwegian Ministry of Foreign Affairs (MFA) annually invested 211,000 USD (NOK at rate 9.4 to USD) in the SLNMC. They contracted Concerts Norway (hereafter CN), a Norwegian governmental music organisation, as the main responsible project owner, who again made sub-contracts with the local partners in Sri Lanka. The goal was to "... stimulate the performing arts in Sri Lanka, *thus contributing to the peace and reconciliation process*" (CN 2011). The programme included two flagship-festivals in Jaffna (situated in the mainly Tamil-populated north) and in Galle (in the Sinhala-dominated south), school concerts with Sri Lankan and international musicians, public concerts, open workshops, university masterclasses, international tours, study trips, training of sound engineers, regional exchange and last but not least; collection, documentation and dissemination of Sri Lankan folk music through a newly established Folk Music Conservation Center in Colombo. The project formally ended in 2018.

RESEARCH PROFILE AND METHODOLOGY

The motivation behind this current study stems from my professional experience and background. As a previous employee of CN, I have been involved as a project manager in a range of music cooperation-projects with countries in the global South. At the end of my working period in CN, I sensed a growing discomfort with the notion of 'harmony' in the SLNMC. Phrases such as "bringing together individuals and groups of different origin and working for peace and harmony" and "Harmony: Unity in diversity!" appeared and reappeared in project documents and media reports that we released. On the outside, it all looked great, but inside the project, the term was understood in ambiguous ways. In 2010, in Oslo, I recall a group of low-country Sinhala Buddhist drummers and mask dancers from southern Sri Lanka¹ were scheduled to share stage with Tamil singers and dancers residing in Norway. As

¹ The *yak tovil* tradition presented by this ensemble includes mask dancing and drumming to eradicate illnesses brought on by demons (Sykes, 2018: 21, Kapferer, 2005). The conducted several performances in Oslo, for example at the International Museum of Children's Art and at the Museum of Cultural History in addition to an outdoor concert at Oslo City Cultural Night along the prominent Aker river.

organizers, we were happy to offer a Sri Lankan cultural evening in the name of reconciliation; yet after the Tamil troupe had performed and the joint ceremony was over, they did not stay back to watch the Sinhala artists. For them, performing and then leaving was a way of respecting the organizers, while at the same time marking no will to communicate with and reconcile with the Other (Tamil vocal teacher in Oslo, personal communication 2018). I could have cited many such incidents in Norway and in Sri Lanka, both self-experienced and situations shared by informants in research interviews. I will come back to some of them in the findings section. Yet, my purpose of bringing the topic up here is to pinpoint some tensions of the SLNMC that sparked my interest in conducting this study.

My research data consists of field observations, interviews², program documents, reports, media clips and other written sources documenting the activities and musical choices of the SLNMC between 2009 and 2018. Through these sources, I sought to identify the discourses and actions of harmony in the SLNMC. Framing my study in a postcolonial context (McEwan 2019) and being conscious about my white, Norwegian middle-class background and the values, positionality and limits attached to that, I explicitly sought knowledge about the perception of harmony as an interrelated term in a cultural context (elaborated in section 5.3). Furthermore, it seemed obvious to involve the Sri Lankan stakeholders and participants in the *whole* research process, both as contributors of data as well as fellow investigators. In February 2018, we held a research forum in Colombo where my Australian colleague, Dr. Gillian Howell and I presented our preliminary findings from the SLNMC and asked practitioners, musicians, students and senior academics to share nuances and constructively discuss elements from our research that they would perceive differently³. I have also exchanged full text drafts with Sri Lankan academic colleagues and participants of the SLNMC in the process of writing this article. I do not claim this as a comprehensive study of harmony in the SLNMC, as I am well aware that given feedback is conveyed with a particular cultural backdrop consisting of a certain set of expectations, values and beliefs (Bass 2013: 17). I nevertheless hope that this article, by unpacking key significations of the harmony-metaphor in the SLNMC, can contribute to increased conceptual clarity and fruitful reflection on praxis.

RELATED RESEARCH

Before moving on to unpacking the harmony-metaphor, I will share a brief overview of what previous research says about harmony and its link to conflict transformation and reconciliation processes.

Academic interest in musical harmony as a combined metaphor cum tool in processes of conflict transformation is not new (Skylstad, 1993 and 2008; Levinge, 1996; Cohen, 2005). In this last decade, the concept has however received increased research attention, with Urbain's *Music and Conflict Transformation: Harmonies and Dissonances in Geopolitics* (2008) as a monumental contribution, crossing the disciplinary fields of musicology, ethnomusicology and sociology. Already in its title, the book plays with the fundamental concept we are here grappling with. Yet, instead of unpacking and problematizing the metaphor itself, it provides

² I was in SL with the sole purpose of conducting research for my PhD for a total of five months between October 2017 and March 2019. My main body of thirty-four informants consists of people who, in various ways, have been connected to the process of conceiving, implementing and reporting on this project. This choice is justified by empirical evidence that organizers are the key shaping force of music interventions (Howell 2018: 300). They are, however, not the only influential party, hence I have also included some participants (music teachers, music students and musicians) and other people from the Sri Lankan community with various links to the project.

³ The forum was conducted on February 27th2018 at the Hector Kobbekaduwa Agrarian Research and Training Institute in Colombo from 9 am to 3.30 pm.

informative and thought-provoking frameworks about music and empathy, music and its value in cross-cultural work and questioning music as a “universal language” (Cohen 2008, in Urbain: 26-39). The accounts of music’s link to politics and music as a tool for reconciliation in South-Africa (Gray, 2008: 63-77) constitute valuable inspiration for my subsequent analysis. Furthermore, Bergh (2010) eloquently writes about music in/ as conflict transformation to improve relationships between in and out-groups, yet he does not pick apart the harmony concept itself when analyzing his rich data sets from Sudan and Norway. Numerous studies about music and/ in /as social action have been published lately by members of the recently established SIMM⁴ research network, where Geoffrey Baker is one of the founding members. In his study about El Sistema in Venezuela, one of the world’s most hailed and influential classical music education systems, Baker (2014: 208-209) argues that this organization is a prominent example of how the harmony-discourse masks power:

The rather sinister idea of tuning up children to a single voice is hard to square with claims for democratic functioning, because democracies are not harmonious: they are diverse and discordant (...) The dream of a society that sings in unison, perfectly in tune, evokes the (mono) culture of conformity typically found in cults (Baker, 2014: 208).

Hence, the notion of harmony itself is pulled forward, discussed and challenged. Baker draws on scholars such as Jorgensen (2004) and Broyles (2012) to illustrate his point that not everyone must be fully in tune to achieve harmony: It is indeed of uttermost importance that the jarring notes also find their space in harmony. Last, but not least, one of the latest issues of the journal *Music and Arts in Action* is a special collection of articles that deals with keywords for music in peacebuilding. Here, Howell’s (2018) heuristic framework of harmony evoked in the context of conflict and social division offered important input for my analytical work. Howell proposes five core categories of harmony as (1) as order; (2) as balance; (3) as blend; (4) as moral behavior and (5) as conflict-avoidance, categories I will return to in my next sections.

To sum up learnings from the literature, one can say that mixing up the musical and sociocultural concepts of harmony up can at best be dismissed as a romanization. At worst, it can block genuine attempts of communication between people. Unless the concept is understood and integrated in all its complexity, poorly thought through attempts to create harmony can be counterproductive and even harmful (Cohen 2008, Harwood 2017).

HARMONY: UNPACKING THE METAPHOR

Metaphors are created when a term is transferred from one system or level of meaning to another. Yet, “metaphors are not only ornamental aspects of language, but also frame our thinking and doings in important ways” (Alvesson, 2017: 487). Metaphors are current in all kinds of languages, in all layers of society and fields. Yet, there are fields where the metaphors clearly have a more severe impact than others. Lakoff and Johnson (2003: 243) highlights the distinction between seeing a military attack as a ‘rape’, a ‘threat to our security’ and ‘the defense of a population against terrorism’ and, in a recent personal communication (23.08.2019) about metaphors in international aid and development, Desmond McNeill argues that the most frequent metaphors in development assistance lead to unjustified optimism; an optimism described as ‘culpable’ because it can foster bad policies and subsequent material practices on the ground.

When we transfer a metaphor directly and uncritically from one field to another, metaphors can give us tunnel vision. Instead of triggering creativity and encouraging counter-thinking, they

⁴ The Social Impact of Making Music (SIMM) is an independent international scholarly association founded in 2015 at the University of Gent, Belgium. It includes a wide network of academic researchers and practitioners in the field of music and social research who meet regularly for symposia and conferences (SIMM 2019).

limit us by the fact that we give them a self-evident, literal meaning. As my research subsequently shows, the discourse of harmony in the SLNMC in some cases falls into this category, notably when it is referred to as something uniquely positive, easy and pleasant. Yet, I would also argue that the harmony-metaphor in the SLNMC is not definitively dead; I would rather (re)define it as *frozen*, justified by the fact that a conscious use of this metaphor still seems to have a vast potential. By engaging in a (self)critical and reflexive process, by questioning harmony’s very foundations, my aim here is to *defrost* the metaphor to lounge its critical potential for conflict transformation and reconciliation.

FINDINGS: HARMONY IN THE SRI LANKA NORWAY MUSIC COOPERATION

In this section, I present three musical and three socio-cultural definitions of harmony and establish a link between them based on activities and experiences of the SLNMC. Emerging from a grounded theory perspective based on my research data in dialogue with the above-mentioned literature, I have placed them in corresponding pairs that eventually constitute the structure of my analysis. These pairs are the following:

Types of musical harmony	Corresponding sociocultural model	SLNMC examples
Consonant (Western) harmony: “chords pleasing to the ear” (Shenasi, 2015: 12), “when notes blend together” (harmony, n.d.)	Harmony as sociocultural <i>blend</i> (Howell 2018: 5) where individuals or groups interact and blend in varying degrees with other individuals or groups (see also Barth 1969, Jenkins 2011: 1-19) Harmony as <i>conflict avoidance</i> : Glossing over difference (Howell 2018: 6, Leung et al. 2002)	Jaffna and Galle Music Festivals (JMF & GMF)
Dissonant (Western) harmony: Dissonant chords and notes foreign to the chord; which nevertheless forms a musical whole (Cohn et al. 2001)	<i>Critical engagement</i> with the Other (Higgins 2008, Gottesman 2018), educational dialogue and <i>reflexive inquiry</i> (Freire 2000, Reardon and Snauwaert 2011): Willingness to see, hear and interact with the Other.	University Musical Meeting Spaces (UMMS)
“Musical giving”: Folk culture and ritualistic events where the harmony-conception is linked to the <i>function</i> (not primarily the sound) of the music.	Circulation of <i>gifts</i> between humans and gods (Sykes 2018a) to create harmony as <i>cosmic balance</i> (Howell 2018, Brindley 2012:16).	Folk Music Conservation Center

“AN EASY-LISTENING, PLEASING SOUND”

THE CONCEPT

Music Land is the name of a Disney classic from 1935. The short movie shows a map of Music Land before zooming in on the Land of Symphony. This is a classical-themed kingdom, where the princess, an anthropomorphized violin, gets bored with the slow ballroom music and sneaks out from the castle. Close to the Land of Symphony, across the Sea of Discord, lies the Isle of Jazz. This jazz-themed kingdom, with lively music and dancing, is led by the mighty King Baritone (sax). One day, his son, Prince Alto (sax), decides to cross the Sea of Discord and falls in love with Princess Violin. The story ends happily with a wedding presided over by a double bass minister, as the citizens of both lands dance on the newly built Bridge of Harmony and a rainbow with musical notes appears in the sky. This little gem of a cartoon exposes a condensed version of how we generally understand harmony, both in musical and sociocultural terms. In music, harmony, i.e. playing more than one note at the same time, is what gives richness and

texture to the music. Harmony is usually understood as chords pleasing to the ear, relying on a presumption of sweetness and pleasantness (Shenasi, 2015). By combining intervals in a scale “understood not as a series but a structure” (Cohn *et al*, 2001: 1), numeric proportions make the music appear blended and balanced. This is referred to as *consonant* sound.

A corresponding view within the sociocultural realm is a vision of harmony as *blend* (Howell, 2018: 5) i.e. a mix of diverse elements, such as different social roles, ethnicity, beliefs and opinions, towards a functional whole. This functional whole rests on notions of inclusion and multiculturalism, yet the obstacles to those ideals are manifold. I will come back to them in the discussion of my SLNMC example below. Harmony as *conflict avoidance* (Leung *et al*, 2002; Howell, 2018: 6) is also a relevant term as it implies that individuals subordinate their personal interest to those of the collective. Here, conflict is seen as a source of social disturbance rather than a constructive human process (*ibid*). This may contribute to uphold a certain intercourse and order, but as Leung *et. al* (2002) suggests, it risks creating a superficial type of harmony only, leaving unresolved disputes and emotions bubbling under the surface.



FIGURE 1: Stage performance JMF 2013 (Photography by the author).

JAFFNA AND GALLE MUSIC FESTIVALS

The SLNMC sought to create blended harmony by staging a multicultural festival, alternating between Galle in the (mainly Sinhala) south and Jaffna in the (mainly Tamil) north. This was multiculturalism at display with a strong symbolic effect: Pictures and live images from JMF and GMF went viral all over (and beyond) the island; yet due to unprocessed emotions and many things left unsaid, there is reason to question whether this model can actually lead to a just and sustainable peace.

The example I cited in my methodology section about the Sinhala and Tamil performers sharing (but not actually *sharing*) stage in Oslo can also be linked to this point: While the framing of the event was done in the name of harmony and “blend of cultures”, what actually took place on stage that night was the diametrically opposite. All groups came, they did their musical parts, but the Tamils did not stay back to watch the Sinhala group perform. The musicians did not talk to each other, they did not socially mix, they only played their parts in the harmony show staged by the organizers (project manager notebook 2010; Tamil vocal teacher in Oslo, personal communication 2018).

Even though a stated intention of the JMF and GMF was to celebrate diversity, and that this was applauded by many, they also had to face a contradiction; the paradox of identity (Orjuela 2008: 51). After the war, there was a strategic need to name oppressed groups in order to fight subjugation. This “strategic essentialism” and has been criticized by postcolonial academics such as Spivak (1990) and Bhabha (1994) who says that this entails a risk of reinforcing stereotypes, not eliminating them; because the “... the subordinate group typically mobilizes around identity categories, which the dominant group has made salient” (Orjuela 2008). When naming and creating “boxes” for these groups in the setting of JMF and GMF, nuances seem to have been lost and instead of emphasizing the potential fluidity of the performer’s identity, a static version was confirmed.

Furthermore, the conditions of multiculturalism also, to a large extent, seemed to be defined by the majority, in this case the Sinhalese. In spite of Tamils (and other minorities) being involved, this sometimes appeared to be more for the sake of checking boxes of representativity rather than a genuine concern of blending the groups. Howell (2019) made the following observations during GMF in 2016, when she attended the joint rehearsals and performances of a female *thappu*-ensemble from Kilinochchi (north) and a traditional drumming ensemble from the national Performing Arts Academy in Colombo (south):

The Kilinochchi group played a traditional Tamil drum, the *thappu*, traditionally played by a historically low-status caste. The young women (and one man) in the Kilinochchi group danced while playing. The Colombo group played a more diverse range of drums from the up-country and low-country traditions, including practices that enjoy significant state sponsorship as a ‘national’ representative artform of Sri Lanka. Therefore, there were some differences in the status that the wider social context attached to the groups’ instruments (...) the Kilinochchi group did not travel with their own artistic director, while the artistic director of the Colombo group assumed a directorial role of the rehearsals and performance. The Kilinochchi group deferred most artistic decision-making to him, apart from their own drumming and choreography (...) there were moments of interaction and pairing taking place between the Kilinochchi and Colombo drummers, which could be said to be subverting the conventions of their performance traditions by mixing the distinctive Sinhalese and Tamil sounds together. However, it was a relatively superficial type of blending, highly suitable for a national festival but not attempting to signify a deeper form of exchange. (Howell 2019: 9-10)

Howell highlights how decision-making was dominated by the Colombo group’s artistic director; how it was colored by the fact that the rehearsal space was the Colombo group’s home base (and that the Tamils had to rehearse in a corner of the main room when they wanted to work on their own music) and how much of the performance time and the physical space on the festival stage was occupied by the Sinhalese drummers, something that do not suggest an equal or perfectly harmonious status between the two, even if this was the apparent intention.

“OH, THAT JARRING SOUND”

The violence of a civil war represents a human experience beyond apprehension. In this context, relying on an easy-listening version of the harmonic metaphor is almost like a mockery of the people affected by the conflict. The wounds are so deep, the trauma so profound. Even though it can function as a temporary relief; the artists and the audience truly seemed to enjoy joint musicking and dancing during the first editions of the GMF and JMF (confirmed by informants ASR, JRdS, SS and others during field interviews in 2017 and 2018), it seems obvious that a different kind of engagement with each other is needed to create more profound harmony and sustainable reconciliation after such dramatic events. My next section will introduce the reader to a notion of harmony that can potentially address these traumas. A *dissonant* understanding of harmony carries the prospective to name and integrate individual and sociocultural tensions and use them to improve relations between people from previously belligerent groups.

THE CONCEPT

In music there is not only consonant harmony; there are also dissonant chords where other, more complex intervals are used to create a jarring sound. The dissonance is produced by the simultaneous vibration of the air column at two frequencies that are not harmonically related – a timbral alternation. Dissonance adds richness and powerful tension to the music, but too much of it might make the piece hard to relate to. Finding the right balance is a fine task, frequently explored by avant-garde composers or by free jazz musicians, who commonly subvert the chords. There is also a distinction to be made between dissonant chords and notes foreign to the chord, a differentiation that gradually came to permeate Western compositional practice and music theory from the 18th century (Cohn *et al.* 2001: 4). The tension these elements adds to the music can immediately be heard by the listener, yet if their intended effect is to be understood, it somehow requires an awareness of the norms with which they conflict. The concepts of “harmolodics” introduced by saxophonist Ornette Coleman exemplifies this approach in the sense that he refused to relate to *one* tonal center, where tonal limitations, rhythmic pre-determination and harmonic rules would prevent music’s free expression. According to him, music in its free form holds the potential to heal suffering and pain: “when you are depressed, music seems to be a very good dose of light” (Coleman, 2008: 1:15-1:43). In the following, I will assess how this type of musical harmony eventually propagated light in the SLNMC.

UNIVERSITY MUSICAL MEETING SPACES

When a listener encounters an unknown musical expression, or a musical expression disliked, this can cause irritation or resistance. Yet, it can also lead to curiosity and an aim to explore and accommodate new expressions. Sociocultural relationships can be experienced in the same way. When we dare to deal with those unfamiliar sounds; dare to accept confusion, anger and resistance, it can indeed open us up to new perspectives and creative solutions we did not previously imagine

The University Musical Meeting Spaces is an SLNMC initiative that embodies such an understanding of harmony. The UMMS was launched in the last phase of the SLNMC as a direct consequence of an external evaluation report by Rambukwella & Fernando (2014). They recommended a more clear-cut vision of reconciliation activities as regular *meeting spaces* between citizens, hence the following was conceptualized by the SLNMC stakeholders in 2016: Selected undergraduate music students from four universities in Sri Lanka were scheduled to meet several times per year, alternating between four campuses in Jaffna, Kandy, Batticaloa and Colombo⁵. The host university was in charge of facilitating the meeting space and finding accommodation for the students, all of which, including food and transport, was paid for by the SLNMC. The meeting space itself comprised of a combination of lectures and a joint workshop based on a new theme each time. Examples of such themes were “life cycles” at Colombo University of Visual and Performing Arts in October 2017 and “festival songs and rituals songs” at the Swami Vipulananda College of Music and Dance in December 2017. The students were given ample time to socialize in between the work sessions and each weekend included one or several excursions in the city where the workshop was held. In Jaffna, for example, the students visited the renowned Hindu Nallur temple and in Colombo, they saw different landmarks of the capital. Cultural learning and friendship formation were at the center of the UMMS, something that, according to Howell (2016 and 2018) facilitate that reconciliation and harmony can be achieved. Through relationship molding and a recognition of what each individual/ university group brought to the table, the students found new ways to (re)harmonize.

⁵ Colombo University of Visual and Performing Arts (UVPA), Jaffna University, Peradeniya University (Kandy) and the Swami Vipulananda College of Music and Dance (SVIAS, Batticaloa).

They relied on tradition, but similarly broke loose from it. In their workshops, their musical creations went beyond what was already known. According to Gottesman (2018), musical co-creation and dialogical practice of experimental learning aids the process of rehumanizing the other and encourages participants to take risks, “whether emotional, psychological, technical or physical” (Higgins, 2008: 391). By using methods widely employed in the community music field, the UMMS provided the students agency over their musical engagement and facilitated group debate to critically examine both musical and sociocultural issues. Creation of a common identity and common social values might gradually occur when such negotiation takes place and, as emphasized by Riiser (2010: 22):

... music can have a formative role in identity creation while at the same time embodying prior identities in its production. In other words, there is a reproduction of identities, both ‘new’ and ‘old’.



FIGURE 2: Screenshot of public Facebook-post from UMMS in Batticaloa, December 2017 (Reproduced by permission of Manoj Sanjeev).

The participants of the UMMS were selected on the basis of their motivation and skills of music and dance. Targeting these young future teachers and professionals in the music field, the UMMS created an opportunity to combine artform development (exploration of diverse harmonies in music) and stronger cross-community social relations (linked to sociocultural notions of harmony). Checking in with students who participated in one or several sessions of the UMMS almost two years after the last event, many of them are still in touch and have made “friends for life” (UVPA student, personal communication. This was also emphasized by other students and teachers who took part in the project).

Steadily built on repeated encounters between young people eager to learn and share, musical skills and ample space for socialization, the UMMS stands out as a fruitful initiative of the SLNMC to promote in-depth, lasting relations in Sri Lanka post war.

MUSICAL GIVING AND RECEIVING: A SRI LANKAN TAKE ON HARMONY

This study about harmony in the SLNMC furthermore requires a critique of what we frequently term standard harmonic theory. Referring hitherto to a Western viewpoint with distinction between consonant and dissonant musical harmony, there is reason to question the relevance of this in the Sri Lankan context. Notwithstanding the fact that both Western classical music and Western popular music are present in the musical culture of the island, there seem to be an imbalanced cultural dominance of Western harmonic language when dealing with harmony overall. It is timely to raise questions about colonial/ postcolonial agency and heritage in harmony and how it might color such a project for reconciliation.

THE CONCEPT

Harmony may in fact be more than how the music actually plays out. This is not to claim that the sound has no significance; it does, but definitely not in the same way that we would evaluate it in the West. In Western harmonic language, we often speak about music as in or out of tune, yet this conception of “in tune” does not appear as particularly relevant to Sri Lankan traditional musicians who historically have operated according to a different system; a system that puts music's cosmic *function* and notions of *giving and receiving* first. The *berava*⁶ drumming, for example (thoroughly discussed by Sykes 2018a), has ritualistic functions where music is used to get rid of evil spirits, sickness or to evoke blessings from the divine. It follows very distinct and complex patterns of grammar (Peiris 2018; Sykes 2018b, 2018c) that need to be carefully respected to achieve the desired purpose. In these rituals, the verbal or semantic aspects of the performance matter more than the actual “sound”, but if the drum syllables or words are not pronounced (sounded) right, they lose their sense; they are incorrect. It literary makes sense to claim that the “devil is in the details” here, since any misperformance of the music risks angering the gods, i.e. creating disharmony: “the aesthetic or artistic symbolic processes are valued in accordance with their capacity to achieve balance and harmony in their formation or dynamic by means of their orientation to the Buddha Teaching” (Kapferer 2011: 132).

When we engage with Sri Lankan music on such ontological level, we also discover the importance of (percussion and voice) recitation in the Tamil *koothu* tradition, presented by the SLNMC on numerous occasions. These dance dramas, generally depicting scenes from ancient Hindu epics or Christian stories, are performed in village settings with no amplification technology used. The *koothu* artists are trained to cultivate the distinct sound of their own voice, employing no other singing technique than a high pitch in order to reach the entire crowd. For an untrained ear, the singing- and musical side of *koothu* can appear loud and monotonous, yet it holds very specific functions in the sense that it serves as communication and contributes to tying the audiences and deities together. It is entertainment, ritual harmony and historical awareness combined.

In this sense, both *berava* rituals and *koothu* performances serve as a harmonic *gifts*; tools to bring humans closer to the gods, and also communities closer to each other, since the gifting of

⁶ *Berava* is a caste which is considered as a low caste in Sri Lanka. Even if the rituals originally emanated from this caste, the drummers participating in these rituals today do not necessarily belong to the *berava* caste and Sri Lankans do not use the word ‘*berava*’ when naming the performance or the drummers. The performance is commonly referred to as ‘Sinhalese traditional drumming performance’, yet I consider this to be of too little academic precision in this article.

musical blessings have historically happened across lines of ethnic and religious enclaves in Sri Lanka (see Sykes 2011 and 2018a for useful accounts about this).

THE FOLK MUSIC CONSERVATION CENTER

Contrary to the music and identity-episteme current in today's ethnomusicological and socially related music research, Sykes (2018a) contends that music in its essence is not about an internal self or a property of one's own community; it is rather a gift *from* the gods or *to* the gods; from one community to another:

Once we define some music as things that originated with and can (or must) be exchanged with nonhumans, and one we accept sonic efficacy as ontologically valid, certain musical traditions that the identity paradigm construes as belonging only to one ethnic or religious group emerge as having multi-ethnic or multi-religious history (Sykes 2018a: 48).

This is not the same as avoiding identity politics or denying the origin of a musical system. Based on Reed (2010) and various Sri Lankan sources (Kulatillake 1976 and 1991; Suraweera 2009), Sykes traces an authentic Sinhala musical style back over thousand years, clearly noting that it is *not* Tamil or Indian. Yet, he also contends that it is a "deeply heterogenous tradition that shows countless interactions with non-Sinhalas over the centuries" (Sykes 2018a: 35). The problem, according to him, arises when "music is conceptually taken out of exchange and reformulated as identity" (Sykes 2018a: 57). This has happened a lot over the years in Sri Lanka: The berava drumming, for example, has been appropriated by the Sinhala rulers to elevate Kandy as the cultural capital of the island and used to propagate the idea of an authentic Buddhist culture. Similarly, some Tamil musical expressions have been dismissed as "Indian", to say that the Tamils do not really belong on the island (artistic director of SLNMC, personal communication, 2017).

The Folk Music Conservation Center (FMCC), founded in 2011, set out to document, digitize and disseminate the variety and interconnections between the folk cultures of Sri Lanka. The center was based on an idea that musical roots play an important part in fostering pride and dignity among people of a *nation* (former CN Head of international projects, personal communication 2018, my emphasis), i.e. not only among members of distinct communities. As we have previously seen in this article, this same justification was also evoked when referring to the music festivals in Galle and in Jaffna. Why and how, in terms of harmony, was the FMCC initiative different from these festivals that also featured the traditional folk music and dances of the island? One key to interpretation here may be the how we understand and eventually emphasize the music and identity-episteme. In concerts and festivals, Sykes contends (2018a: 187), (cultural) "groups are defined first by difference and then put on stage and told to interact". He continues:

While inter- ethnic collaborations through music are positive in the that they show to the world that supposedly opposing groups can respect each other enough to play music together, such collaborations may simultaneously project seemingly essential, insurmountable differences between them, even as they harness music to transcend those differences. The link between music and identity is part of the problem not the solution (Sykes 2018a: 186).

The FMCC was envisaged to accentuate the joint trajectories and similarities between many expressions of Sri Lankan music and dance. Its collection aimed to emphasize sameness in Sri Lanka rather than the division lines of its people. Digging into these archives and an interview with its chief producer Dilip Kumara (interviewed in Colombo, November 2017) reveal that this ambition largely seems to have been met: The employees of the archive have interviewed tradition bearers, documented ceremonies and rituals from all regions of Sri Lanka and have also released several documentaries about the same. The basic collection now amounts to more than 17TB of sound and video material and is still growing. The FMCC is in fact the only

SLNMC activity that has sustained after the end of contract with the Norwegian MFA in 2018, as the Sri Lankan Ministry of Culture has mobilized funding for its continued life and work. In March 2019, the FMCC released the CD “Sannaada” (translates as “music”, but in a slightly broader sense than “sangeethaya”), where ten contemporary composers were encouraged to dive into the recordings of the FMCC. The process gave birth to ten pieces of newly made music, named by themes that can unite Sri Lankans across ethnic, religious, urban and rural boundaries⁷. In this album and its accompanying booklet, we can spot referential bridges between the material itself, its historical and contextual roots and its relevance for us today. Sometimes, these links are obvious, sometimes they appear to be more hidden; it is up to the listener to interpret the current signification of the music.

Regardless of which group you belong to, folk music and dance are rich expressions of joy and sorrow, hopes, aspirations and disappointments. This intangible heritage is closely related to routines of work, to religious rituals and key events in life such as birth, marriage and death. Folk music and dance also emphasize links between humans and nature, between earthly and heavenly forces, and in this sense, I argue that the FMCC seen through the lens of harmony as giving and receiving, harmony as *cosmic balance* (Brindley 2012, Howell 2019), offered more than a minor contribution to reconciliation in post-war Sri Lanka.

CONCLUSION

The fact that the metaphor of harmony is so little problematized may indicate that it has become a “dead” – taken for granted – metaphor that have lost its creative and imaginative meaning. Yet, my mapping and subsequent analysis of this metaphor has shown signs of possible internalizing and defrosting of the metaphor for implementing musical activities in a post-war context. It may have the potential to be a creative and impactful tool given the right circumstances.

The metaphor seems most fruitful for peacebuilding when stakeholders and participants engage with its critical potential and recognize the role of tension in both musical and socio-cultural harmony. Another relevant link between musical and sociocultural harmony, is the Sri Lankan “gifting” between communities and gods; emphasizing human links to nature and to a greater cosmos. It accentuates the importance of tuning in and turning towards and listening to each other to recognize that we share fundamental histories, conditions and challenges.

No matter which of these harmony-notions we choose to rely on, one primary condition for harmony as a living metaphor is certain: In order for harmony to function as a creative and impactful tool for musical activities in a post-war context, the *relational* aspect of the notes, the chords, the beats – the people – must not be ignored. We must exist in critical, yet compassionate, relation to each other; not in isolation, nor merely beside each other.

⁷ “The villager’s life”, “King of the Water”, “Mother”, “Earth and Freedom” are examples of titles from this collection (Folk Music Conservation Center 2019).

REFERENCES

- Alvesson, Mats. 2017. Metaphorizing the Research Process. *The SAGE Handbook of Qualitative Business and Management Research Methods: Methods and Challenges*. Edited by C. Cassell, A.L. Cunliffe, and Grandy, G. London: SAGE Publishing, 486-505.
- Baker, Geoffrey. 2014. *El Sistema: Orchestrating Venezuela's Youth*. Oxford: Oxford University Press.
- Barth, Fredrik. 1969. *Ethnic Groups and Boundaries. The Social Organization of Cultural Difference*. Oslo: Universitetsforlaget.
- Bass, Daniel. 2013. *Everyday Ethnicity in Sri Lanka. Up-country Tamil Identity Politics*. New York: Routledge.
- Bergh, Arild. 2010. *I'd like to Teach the World to Sing: Music and conflict transformation*. PhD dissertation, University of Exeter.
- Bhabha, Homi. 1994. *The Location of Culture*. London: Routledge.
- Coleman, Ornette. (2008). Interview within "Boonaroo MusicFest". <https://www.youtube.com/watch?v=8CoPGDfMWfc>: 1:15-1:43., last accessed 22 April, 2020.
- Brindley, Erica Fox. 2012. *Music, Cosmology, and the Politics of Harmony in Early China*. New York: State University of New York Press.
- Broyles, Michael. 2012. *The American Symphony Orchestra as a Political Metaphor*. Paper delivered at American Musicological Society Conference, New Orleans, November 3.
- Charbonneau, Louis. 2009. U.N.'s Ban Says Sri Lanka Needs Help for Refugees. Reuters Press. Retrieved from <https://www.reuters.com/article/us-srilanka-war/u-n-s-ban-says-sri-lanka-needs-help-for-refugees-idUSTRE54L0YW20090523>, last accessed 22 April, 2020.
- Cohen, Cynthia. 2005. Creative Approaches to Reconciliation. *The Psychology of Resolving Global Conflicts: From War to Peace*. Edited by M. Fitzduff and C. Stout. Westport: Greenwood Publishing Group.
- Cohen, Cynthia. 2008. Music: A Universal Language? In O. Urbain (ed.): *Music and Conflict Transformation: Harmonies and Dissonances in Geopolitics*. London: I. B. Tauris, pp. 26-39
- Cohn, Richard, Brian Hyer, Carl Dahlhaus, Julian Anderson, and Charles Wilson. 2001. *Harmony*. In Oxford Music Online. Retrieved from <https://doi.org/10.1093/gmo/9781561592630.article.50818>, last accessed 22 April, 2020.
- CN 2011: Second phase, SLNMC project document. Unpublished ms.
- Disney, Walt. 1935. *Silly Symphony: Music Land*. Retrieved from <https://www.youtube.com/watch?v=mWFsKmH41uo>, last accessed 22 April, 2020.
- Folk Music Conservation Center. 2019. Sannaada. The Symbol of Sri Lankan Identity towards Universal Music. Ten Musical Pieces of Sri Lankan Artists. (CD and booklet). Colombo: FMCC.
- Freire, Paulo. 2000. *Pedagogy of the Oppressed*. Bloomsbury: Bloomsbury Publishing.
- Gray, Anne-Marie. 2008. Music as a tool of reconciliation in South Africa. *Music and Conflict Transformation: Harmonies and Dissonances in Geopolitics*. Edited by O. Urbain. London: I. B. Tauris, 63-77.
- Gottesman, Shoshana. 2018. Dialogue. *Music & Arts in Action*, 6 (2): 17-28.
- harmony. (n.d.). Dictionary.com Unabridged - Harmony. Retrieved from <http://www.dictionary.com/browse/harmony>, last accessed 22 April, 2020.
- Harwood, Jake. 2017. Music and Intergroup Relations: Exacerbating Conflict and Building Harmony through Music, vol. 5: pp. 1-31. *Review of Communication Research*, 5, doi:10.12840/issn.2255-4165.2017.05.01.012.

- Higgins, Lee. 2008. Community Music and the Welcome. *International Journal of Community Music*, 1(3): 391-400.
- Howell, Gillian. 2016. *Music, Development, and Reconciliation in Sri Lanka*. Report to the Sri Lanka Norway Music Cooperation.
- Howell, Gillian. 2017. *A World Away from War: Music Interventions in War-affected Settings* PhD dissertation, Queensland Conservatorium, Griffith University, Australia.
- Howell, Gillian. 2018. Harmony. *Music & Arts in Action*, 6 (2): 1-14.
- Howell, Gillian. 2019. *Making Harmony, Building Peace: A Framework for Music-based Peacebuilding Drawing on Harmony as a Core Value in Asia*. Paper presented at 'Varieties of Peace Conference', University of Jakarta. October 23.
- Jenkins, Richard. 2011. *Being Danish: Paradoxes of Identity in Everyday Life*. Copenhagen: Museum Tusulanum.
- Jorgensen, Estelle. 2004. Pax Americana and the World of Music Education. *Journal of Aesthetic Education* 38 (3): 1-18.
- Kapferer, Bruce. 1983. *A Celebration of Demons: Exorcism and the aesthetics of healing in Sri Lanka*. Bloomington: Indiana University Press.
- Kapferer, Bruce [1988] 2011. *Legends of People, Myths of State: Violence, Intolerance and Political Culture in Sri Lanka and Australia*. Washington: Smithsonian Institute Press.
- Kapferer, Bruce. 2005. Sorcery and the Beautiful. A Discourse on the Aesthetics of Ritual. *Aesthetics in Performance. Formations of Symbolic Construction and Experience*. Edited by Angela Hobart and Bruce Kapferer. New York: Berghahn Books, 129-160.
- Kulatillake, Cyril de Silva. 1976. *A Background to Sinhala Traditional Music of Sri Lanka*. Colombo: Department of Cultural Affairs.
- Kulatillake, Cyril de Silva. 1991. *Ethnomusicology. Its Content and Growth; and Ethnomusicological Aspects of Sri Lanka*. Colombo: S. Godage and Brothers.
- Lakoff, George and Mark Johnson. [1980] 2003. *Metaphors we Live by*. Chicago: University of Chicago Press.
- Leung, Kwok, Pamela Tremain Koch, and Lin Lu. 2002. A Dualistic Model of Harmony and its Implications for Conflict Management in Asia. *Asia Pacific Journal of Management*, 19: 201-220.
- Levinge, Alison. 1996. Discord or harmony. *Arts Approaches to Conflict*. Edited by M. Liebmann. London: Jessica Kingsley Publishers, 237-245.
- Mahahegawa, Tharooshie. 2014. "Await the Return of the Galle Music Festival". *Sunday Times*, March 2, 2014.
- McEwan, Cheryl. 2019. *Postcolonialism, Decoloniality and Development*. New York: Taylor & Francis.
- Orjuela, Camilla. 2008. *The Identity Politics of Peacebuilding: Civil Society in War-Torn Sri Lanka*. New Delhi: SAGE Publications.
- Peiris, Eshantha. 2018. Changing Conceptualizations of Rhythm in Sri Lankan Up Country Percussion Music: From Rhythmic Contours to Metric Cycles. *Analytical Approaches to World Music*, 6 (2): 1-31.
- Rambukwella, Harshana and Mangala Fernando. 2014. *Evaluation Report of the Norway-Sri Lanka Music Cooperation Programme*. Report commissioned by the Royal Norwegian Embassy in Colombo.
- Rambukwella, Harshana. 2018. *The Politics and Poetics of Authenticity: A Cultural Genealogy of Sinhala Nationalism*. London: UCL Press.

- Reed, Susan. 2010. *Dance and the Nation: Performance, Ritual and Politics in Sri Lanka*. Madison: University of Wisconsin Press.
- Reardon, Betty and Dale T. Snauwaert. 2011. Reflective Pedagogy, Cosmopolitanism, and Critical Peace Education for Political Efficacy: a Discussion of Betty A. Reardon's Assessment of the Field. In *Factis Pax*, 5(1): 1-14.
- Riiser, Solveig. 2010. National Identity and the West-Eastern Divan Orchestra. *Music & Arts in Action*. 2 (2): 19-37.
- Shenasi, Solmaz Yasamin. 2015. The roots of music therapy: Healing the wounds of the psyche. Master of Arts in Counseling Psychology. Pacifica Graduate Institute. Retrieved from https://media.proquest.com/media/pq/classic/doc/3677263081/fmt/ai/rep/NPDF?_s=oibFFMgrEWwnlm%2BdeUr9IzHI%3D , last accessed 20 December, 2019.
- SIMM. 2019. Social Impact of Making Music (homepage). Retrieved from <http://www.simm-platform.eu/> , last accessed 22 April, 2020.
- Skjellstad, Kjell. 1993. *The Resonant Community (1989-1992). Fostering Intercultural Understanding through Music*. Summary report. Oslo: University of Oslo.
- Skjellstad, Kjell. 2008. Managing Conflicts through Music: Educational Perspectives. In Urbain: *Music and Conflict Transformation: Harmonies and Dissonances in Geopolitics* (pp. 172-184). London: I. B. Tauris.
- Sorbo, Gunnar, Jonathan Goodhand, and Bart Klem. 2011. *Pawns of Peace: Evaluation of Norwegian Peace Efforts in Sri Lanka, 1997-2009*. Evaluation report 5/2011. NORAD: Oslo.
- Spivak, Gayatri. 1990. *The Postcolonial Critic: Interviews, Strategies, Dialogues*. Edited by Sarah Harasym. New York: Routledge.
- Suraweera, Sumuditha. 2009. *Sri Lankan Low-Country Ritual Drumming: The Raigama Tradition*. PhD dissertation. University of Canterbury.
- Sykes, Jim. 2011. *The Musical Gift: Sound, Sovereignty, and Multicultural History in Sri Lanka*. PhD dissertation, University of Chicago.
- Sykes, Jim. 2018a. *The Musical Gift: Sonic Generosity in Post-War Sri Lanka*. New York: Oxford University Press.
- Sykes, Jim. 2018b. South Asian Drumming Beyond Tala: The Problem with "Meter" in Buddhist Sri Lanka. *Analytical Approaches to World Music*, 6 (2): 1-49.
- Sykes, Jim. 2018c. On the Sonic Materialization of Buddhist History: Drum Speech in Southern Sri Lanka. *Analytical Approaches to World Music*, 6 (2): 1-74.
- Urbain, Olivier. 2008. *Music and Conflict Transformation: Harmonies and Dissonances in Geopolitics*. London: I. B. Tauris.

WAYS OF SINGING IN NAPO COUNTY (GUANGXI ZHUANG AUTONOMOUS REGION) AND IN FUNING COUNTY (YUNNAN PROVINCE)

Lin Zhi [林芝]

Guangxi Arts University, contact: 380075515@qq.com

Abstract

Songs have their specific circulation area in the process of their development. Due to the geographical background, local language dialects, and varying social background, the style and characteristics of songs in various places are revealing specific characteristics. The lyrics of these songs are based on the people's spoken dialects. Therefore, various dialects' voices, the ways of making them sound, local accents, terms used and exclamations, have been brought into these songs, thereby forming regional differences of songs to some extent.

This study is based on intense field work undertaken in the past few years. It deals with ways of singing in Napo County and Funing County in the South of China.

Keywords

Singing practice, field work, Zhuang, Guangxi, Yunnan

WAYS OF SINGING

The songs of the Zhuang people in Napo and Funing counties are performed without instrumental accompaniment. Under usual circumstances as far as it is known, most of them are in the way of male and female alternating singing, solo singing, repetitive singing, and joint singing of some more people together. When singing alternately, the number can be one man and one woman, two men and two women, or more men and more women. When singing, one party sings a text first and the other sings it again, so the song is continued through many repetitions. Before the 1960s, the Zhuang people held solemn song festivals in their fields. Today, the Zhuang songs mostly appear in organized seasonal festivals, singing competitions and other activities organized by the government or the respective communities. Most of the singers stand while singing and are performing towards the audience. But in their leisure time, the singers may stand, sit, or squat comfortably. The following table illustrates the different positions:

Locality (地方)	[Type]	Song title	Way of singing
那坡县 Napo	单声部 Single voice	[luən ⁴ ʔja:ŋ ¹] luenx yang 论央	男女对唱, 少数独唱; 亦可男女双方相等人数 (二至六人) 齐唱的对唱形式, 但较少见。 In the centre alternating singing males, a few soloists; an alternating singing of equal numbers of performers (two to six) by both men and women. Very rare.
	双声部 Two voices	[θei ¹ rai ⁶] sei reih 诗上甲	对唱, 多为两男二重与两女二重的人员编制; 非正式场合可仅同声重唱的形式, 人员编制可两人重唱, 也可一人高声部、两人低声部的组合形式。

			The first part of the sung poem is with alternating singers, usually by two men and two women. The informal arrangement can only be performed in the same voice. It is combining either two people, or one person with a high voice and two with a low voice.
		[θei¹ na²] sei naz 诗下甲	男女对唱，双方人员声部组合形式有同声二重唱与同声合唱两种。同声合唱时一人演唱高声部，两人或以上（上至可达三十人）演唱低声部。 The lyrics are expressed in the singing of two men and women who sing together. The voices of the two sides can be combined in two ways: joint singing and joint chorus, in which one person sings the high voice, and two or more (up to 30 people) sing a low voice.
富宁县 Funing	单声部 Single voice	[fu:n¹ ʔja:ŋ¹] fwen yang 吩央	男女对唱，少数独唱；亦可男女双方相等人数（二至六人）齐唱的对唱形式，但较少见。 Fenyang is alternating singing between male and female. Some are sung as solo. It is also possible to sing with equal numbers of singers (two to six), but it is rare.
		[fu:n¹ ə⁰ ei⁰] fwen wei 吩呢哎	对唱、齐唱、独唱等三种形式均有。对唱时一方为主要旋律演唱者，另一方起到短暂承接作用。齐唱一般为二到三人。 There are three ways: alternating singing, more singers in a single voice, or a solo performance. During the singing, one leads the main melody, and the other side sings a short phrase. When singing together, there are usually two to three singers.
		[fu:n¹ ŋa¹ wi³] fwen nga rij 吩丫玉	多数为独唱，亦可齐唱 Most ways of singing are as solo, but there can be more singers performing in one voice.
		[fu:n¹ ta⁶ la:u⁴] fwen dah laux 吩打劳	独唱 Solo singing
	双声部 Two voices	[fu:n¹ the:n¹ pa:u³] fwen dien bauj 吩天保上甲	男女对唱，各方最少为两人，最多八人，由一人唱高声部，其余唱低声部；休闲联系时可二重唱。 The first part of the Fen Tianbao is a pair of alternating singings between male and female. There is a minimum of two parties and a maximum of eight parties joining. One person sings the high voice and the rest sings the low voice. The alternating singing can be used for casual contact making.
		[fu:n¹ the:n¹ pa:u³] fwen dien bauj 吩天保下甲	男女对唱，最少三人，最多十人，由一人唱高声部，其余唱低声部；休闲联系时可重唱，最少三人，一人高声部，两人低声部。 The first part of the lyrics is sung alternately by male and female singers, at least three people, at most ten people, one person sings the high voice, the rest sings the low voice. It can be changed at leisure times, at least three people, one high voice, two low voices.

FIGURE 1: Table of different ways of singing songs of the Zhuang people (Scheme by the author).

SPECIFIC SONG FEATURES IN NAPO COUNTY

“论央” [luən⁴ ʔja:ŋ¹]: This tune is sung with a wide range of frequencies and a combination of so-called true and false sounds, which is characterized by requiring the singer to have a long breath and leaving no traces of secretly breathing. When singing in high pitches, the head cavity resonance and chest cavity resonance are mostly used to make the sound extremely tension-bearing and elastic. When singing the ending phrases, the singer often uses ‘false voice’ to slide up or down. "Lunyang" has a free and complex rhythm, and often uses a variety of micro-melodic patterns such as vibrato, tied tones through slides, and other micro-melodic elements, which are possibly decorative through changes.

“诗上甲” [θei¹ rai⁶]: The melody is and the rhythm is clear. The entire song is short. Usually, only two main beats are used to open the song. The pitch range is narrow. Trills are occasionally used, possibly to decorate the melodic space.

“诗下甲” [θei¹ na²]: In the melody, the pitches are modified through slides and glides, resulting in different effects of coloring the song. Generally speaking, the real voice is used for singing, the male voice is louder, the female voice is moderate, and the tone is soft, forming a clear auditory effect.

SPECIFIC SONG FEATURES IN FUNING COUNTY

“吩央” [fu:n¹ ʔja:ŋ¹]: This melody has a fully used and high-pitched wider singing range that can carry over a long distance, and is characterized by a relatively long last part. Singing often uses real voices, and frequently alternates with false voices. There are three vocal techniques of expressing a rising, a middle and a low pitch, which are used to set the language tone. The way of singing depends on it.

“吩呢哎” [fu:n¹ ə⁰ ei⁰]: This kind of tune is simple and straight forward, with a strong piercing sound. It has very high requirements on the singer's technical skills and breath control. It is a longer lasting song. Its characteristics are seen in the fact that the singer needs to alternate between true and false voices without breaking apart. When using real voice, the singer must have a strong and full tone, when the voice is false, the tone is clean and bright. The song also uses a large number of micro-melodic patterns, probably as decoration, such as titling pitches, vibrato, and tied tones. The singer needs to interpret them carefully and coherently. Because such tunes are rather free, the rhythm is not regular, and there is a certain freedom of rhythmic shapes. The time value changes according to the singer's state of mind and other factors. It also reflects on the skills of the singer's breath.

“吩丫玉” [fu:n¹ ŋa¹ wi³]: The title means something like "Mountain Spring Tune". As the name suggests, this kind of tune is relatively gentle, the melody stretches in a soothing way, calm and leisurely, and it is often used to alternate between true and false voice when singing, like a stream flowing through the mountains. Smart, like a drop of water evoking ripples.

“吩打劳” [fu:n¹ ta⁶ la:u⁴]: This kind of tune is divided into "Undressing Lao Fen Lao" and "A Fei Fing Laou". Light and smooth, often used to sing love songs, its melody structure is relatively independent, easy to teach and easy to sing.

“吩天保上甲” [fu:n¹ the:n¹ pa:u³]: This tune is high-pitched, with strong penetrating power, many long tones, and a simple rhythm in short phrasings. It is characterized by the use of the throat vibrato when singing in high-pitches to identify the upper and lower part.

“吩天保下甲” [fu:n¹ the:n¹ pa:u³]: The lower armour tune is pitch-wise lower than the upper armour, and the melody is smooth and lasting longer. It is sung with more real voices, clear straight words, a more decisive melody and less large melodic jumps.

Each way of singing in Zhuang songs has its own technicalities and characteristics. However, in general, in the singing method, the songs of the two places selected above use more real and false sounds alternately. In the song, Napo 's “Lunyang”[论央] has a certain similarity with Funing's “Fenyang”[吩央]; Napo 's “Poem on the Apocalypse (Shi Shangjia/Poems of Shangjia)”[诗上甲] and “Poem on the Bottom of the Poem (Shi Xiajia/Poems of Xiajia)”[诗下甲] and Funing 's “Fentianbao on the Apocalypse (Fentianbao Shangjia)”[吩天保上甲] and “Fentianbao on the Apotheosis (Fentianbao Xiajia)”[吩天保下甲] are certainly similar.

PEOPLE'S UNDERSTANDING OF THE TUNES

The types of the “论央” [lu:n⁴ ?ja:ŋ¹] include high [ka:u⁵ tha:n²], middle [tsuŋ⁵ tha:n²], and low [ti⁵ tha:n²] registers. Among them, the low [ti⁵ tha:n²] also includes the irregular register [luən⁴ tha:n²]. Regarding the names of the tunes described above, the Zhuang language is expressed using Mandarin of Southwestern China. There is no special Zhuang language term, but the description and naming can be understood in Zhuang language.

Interview time: 6 February, 2018

Interview location: Office of Culture, Sports, Radio and Television, Bureau of Napo County

Interview form: Individual interview, open

Basic information of the interviewees: Luo Jingchao, male, born October 1958, Zhuang, attached to the program on the national intangible cultural heritage “Napo Zhuang People's Songs”

Interview content:

Author: Hello, Mr. Luo! I saw in the book that the starting tunes of Napo 's "theory of centralism" are high, middle and low registers, and there are also irregular registers, right?

Luo: Yes, the high one is a mountain cave. To go to the (high) place means to sing suŋ¹ suŋ¹ pai¹ (high).

Author: What about the middle and low registers?

Luo: The low one is for tsam¹ tsam¹ ke:m¹ kwa⁵ pai¹ (follow it slowly), and then ?ju⁵ tam⁵ tam⁵ khən³ pai¹ thəŋ¹ tiŋ² kja:ŋ¹, tiŋ² kja:ŋ¹ joukh khən³ pai¹ thəŋ¹ suŋ¹ suŋ¹ pai¹ (Those are in the middle section, and then they rise to a high place in the middle section).

Author: What about the middle register?

Luo: The middle one is for tiŋ² kja:ŋ¹ (middle). At ti:ŋ² kja:ŋ¹ khən³ pai¹ tiŋ² suŋ¹ (up to the middle), this is the middle register.

Author: What about the irregular one?

Luo: The irregular one is considered within the low register.

Author: Are they exactly the same?

Luo: No, what should I say? It is lower than the low-key (altar) and tam⁵ (low). For example, the two of us sat on the bench and sang together, and then we started to sing very little. Just like this (humming a short sentence).

Author: Thank you Mr. Luo. So how do I say in Zhuang language high, middle, low, and irregular register?

Luo: Oh, I don't know how to say this. We usually say it in Mandarin. We all say it that way.

Author: How do I understand it in Zhuang language?

Luo: The high register is tsei⁴ suŋ¹ (highest), meaning the mountain cavity, the low is tsam¹ tsam¹ tam⁵ tam⁵ ke:m¹ kwa⁵ pai¹ (following slowly), the middle register is ʔju⁵ tiŋ² kja:n¹ khən³ tiŋ² suŋ¹ pai¹ (rise in the middle and going to the high place), the irregular register also belongs to the low altar, but it is tsei⁴ tam⁵ tsei⁴ tam⁵ (low and lowest).

Author: What is the Chinese character for "tha:n⁵"?

Luo: There is no (Chinese) character. The upper (high) register is the high pitch, the middle register serves the middle pitch, the low register is the bass, and the irregular register is an even lower pitch. For example, in the past, at home, from nine to midnight to eleven and twelve at night, we sang the middle register, and then at twelve thirty, one o'clock in the middle of the night, we started singing the irregular one. The voice will sing low, because there are elderly people in the family going to sleep. We cannot disturb the elderly's sleep. So, we do not let them hear, so I sing in an irregular register. The irregular register is sung like this. The old houses were made of wood. When the guests came to sing, they let the guests sit in the back room. We sat in the hall, sat down on the bench, and then they people were leaning against the wooden wall panels of the back room. They sing, others listen to them, and then we answer, rather quietly.

Author: So, you did not meet while performing the song?

Luo: No, there is no meeting. It's going across the wall. Then, it would have been time for supper, which was more than three o'clock in the middle of the night, so we invited people in the back room to have supper. At this time, they came out, and when they came out, the sound started to rise a little bit, but this time it wasn't too much, or too low. After eating supper, the guests went back inside, at this time they continued to sing and others started singing back to that irregularly. I sang this way and sang until I looked up at the sky. When the sky was bright, about six o'clock in the morning, we started singing the middle register. At that time during the rule of the Kuomintang (as experienced from the old society), there were no electric lights, no clocks, therefore, we only looked at the sky. At this time, the old man started to get up. After getting up, we went to boil (pork rice), bring water, grind rice, feed chicken, etc., we sang the middle register. At that time, we were ready to go back, we went to the gate, ready to go home to sleep, and began to sing high register, sing love songs, sing lu:n⁴ pja:k⁸ (parting song), ready to separate, that is the kind of "high mountain cave". At the time of the Spring Festival, there was too much rain and it was too cold. It was quite tiring to sing a night. There was a day to go home to sleep. If they still see guests from outside the village at night, those people may continue to sing with the guests at night.

Author: Thank you Luo. Which Chinese character do you think the "tha:n⁵" character is best?

Luo: If you want to write, I think it's better to write the "talk" next to the words.

Author: Are you talking about "talking"?

Luo: Yes, the "talk" of the conversation. We can understand everything we write."

From the above materials, the author believes that in addition to the role of high, middle, low, and irregular register, singing songs also includes two aspects of the singer's environment when singing, and the aesthetic standards established by Zhuang people. Mainly, singing songs also reflects on the etiquette and customs of the Zhuang songs: 'respecting the elderly' and 'respecting the guests.' The interview presented above can be taken as an example. In the

following, the author summarizes the verbal understanding of the "Lunyang" tune as shown in the table below:

Named as	Phonetic appearance	alias	Oral characteristics		Environment
			Zhuang (phonetic transcript)	Chinese translation	
High register	ka:u ⁵ tha:n ²	shàng tán gāoyīn 上坛高音	1、suŋ ¹ suŋ ¹ pai ¹ 2、tsei ⁴ suŋ ¹	1、高高的 2、最高	第二天早上走出大门，返程唱“别离歌”的时候 The next morning, when I walked out the door and sang "Farewell Song" on the way back.
Middle register	tsuŋ ⁵ tha:n ²	zhōngyīn 中音	1、tiŋ ² kja:ŋ ¹ 2、tiŋ ² kja:ŋ ¹ khən ³ pai ¹ tiŋ ² suŋ ¹ 3、ʔju ⁵ tiŋ ² kja:ŋ ¹ khən ³ tiŋ ² suŋ ¹ pai ¹	1、中间 2、中间升到高处 3、在中间上升到高处	1、晚上九点多到半夜十一点、十二点在家中 2、次日天蒙蒙亮，大概六点钟左右，老人起床干家务活的时候 1. 9:00 p.m. to 11:00 p.m. and 12:00 p.m. at home. 2. The next day, at dawn, around six o'clock, when the old man got up to do his chores
Low register	ti ⁵ tha:n ²	dīyīn 低音	1、tsam ¹ tsam ¹ ke:m ¹ kwa ⁵ pai ¹ , ʔju ⁵ tam ⁵ tam ⁵ khən ³ pai ¹ thəŋ ¹ tiŋ ² kja:ŋ ¹ , tiŋ ² kja:ŋ ¹ jəu ⁶ khən ³ pai ¹ thəŋ ¹ suŋ ¹ suŋ ¹ pai ¹ 2、tsam ¹ tsam ¹ tam ⁵ tam ⁵ ke:m ¹ kwa ⁵ pai ¹	1、慢慢地跟过去，在很低的地方升到中间段，然后在中间段又升到很高的地方 2、慢慢地、低低地跟去	半夜三点左右夜宵时间，客人从里屋向厅堂走出来的时候，声音既不太中，也不算太低 At about three o'clock in the middle of the night, when the guests came out of the inner room toward the hall, the sound was neither too moderate nor too low
Irregular register	luən ⁴ tha:n ²	Zuidīyīn 最低音	tsei ⁴ tam ⁵ tsei ⁴ tam ⁵	最低最低	1、半夜十二点半、一点老人睡觉时，部分歌手在厅堂，部分歌手在里屋，隔着木头墙板 2、半夜三点钟，客人吃完夜宵回到里屋坐下后 1. At 12:30 or 1:00 in the morning when the old people are sleeping, some singers are in the hall and some singers are in the inner room, sung through the wooden wall panels 2、At 3 o'clock in the middle of the night, after the guests have eaten their nightly snack, then going back to the inside room and sit down

FIGURE 2: Table about the situation of the "论央" Lunyang (Scheme by the author).

SUMMARY

Based on the data collected during the field survey, the author has conducted research on Napo and Funing counties involved in this study and created a brief overview about the large diversity in singing techniques, opportunities, and contextual appearances at the time and in the spaces of observation. This can help improve understanding of historical patterns and recent developments toward another performance culture.

LITERATURE RECOMMENDED

- Dictionary Editorial Office, Institute of Languages, Chinese Academy of Social Sciences. 2013. *Dictionary of Modern Chinese (6th Edition)*. Beijing: Commercial Press.
- Guan Jianhua. 2013. *An Introduction to the Anthropology of Music*. Nanning: Nanning Normal University Press.
- Guangzhou Institute of Foreign Studies. 2010. *The Thai-Chinese Dictionary*. Beijing: Commercial Press.
- Li Fanggui. 2011. Li Fanggui's Complete Collection 8: A Handbook of Comparative Taiwanese. Beijing: Tsinghua University Press.
- Liang Min and Zhang Junru. 1996. *An Introduction to the Dong-Tai Language Group*. Beijing: China Social Science Press.
- Liang Min, Zhang Junru, et al. 1999. *A Study of Zhuang Dialects*. Chengdu: Sichuan Ethnic Press.
- Miao Jing and Qiao Jianzhong. 1985. On the Delineation of the Approximate Colour Zones of Han Folk Songs (Upper). *Journal of the Central Conservatory of Music*, 1: 26-33.
- Napo County Bureau of Culture, Sports, Radio and Television. 2015. *Folk Songs of the Napo Zhuang People*. Nanning: Guangxi People's Publishing House.
- Rao Bingcai. 1983. *The Guangzhou Dictionary of Sounds*. Guangzhou: Guangdong People's Press.
- Xu Hanmei. 2010. An Analysis of the Singing Voice of the Black-clad Zhuang Shan Song. Beijing. *China Music (Quarterly)*, 4: 186-189.
- Zhao Talimu. 2001. The Concept and Taxonomy of Folk Songs of the Central Asian Donggan People (upper). Beijing: *Journal of Chinese Academy of Music*, 1: 47-52.
- Zhou, Guowen, 2005. *Guixi Zhuang Folk Songs in Perspective*. Beijing: Popular Literature Press.

REMARK

For more information about transcriptions, refer to international phonetic symbols for the Zhuang language.

THE SISTRUM AND THE STICK RATTLES SABAYI AND SACHI

Long Fei [隲菲]

Contact: 290452737@qq.com

Abstract

This paper gives a brief outline of inherited links between various instruments. In doing so, attention is given to their spread and transformation process from an ancient Egyptian sistrum to a different type of a stick rattle¹, also known as xi-stick or *xízhàng* in Chinese. This instrument once existed during the middle ages. In the process of time however, its use was witnessed in the Uyghur's' *sabayi*, the *sachi* and further to the Vietnamese *sinh tien* and the Japanese *suzu*.

These instruments can create a rapid succession of rattling and complex sounds, some of which simulating frogs croaking during tropical rainy seasons. Other sounds imitate the repeated thrum of rattlesnakes searching for a spouse. Depending on time and place, the former are linked with praying for rain and the latter with reproduction.

Thus, the rattles this study discusses are, among others, used in prayers for fertility and rain, peace and safety, healing rituals (curing diseases), for longevity. Furthermore, these rattles are sounded to ward off evil spirits, exorcise plagues and to keep poisonous animals away. All these resemble the mythological connotation to the copulating of Fuxi and Nuwa. Hence, they belong to the specific worldviews closely connected with the importance of reproduction in early times of humankind. They all involve fertility, death, reincarnation, eternal life, and the function of triggering trance, in which people seem to feel connected with heaven and earth, deities or ancestors.

Keywords

sistrum, stick rattle, *sabayi*, *sachi*, ritual use

INTRODUCTION

In this paper, I introduce some ideas regarding the stick rattle. In figure 1, there is a long stick with a rotatable peach-shaped frame on top, made of a number of metal bars to which loosely fitted are six or twelve rings, making a specific sound like “xi” upon being shaken. Those types of instruments are seemingly common in images depicting Buddhist events as seen in an earlier publication *Materials of Chinese Music History in Dunhuang Frescoes* (Long Fei 隲菲, 1991: 446-450).

FIGURE 1: One shape of a stick rattle. (Photograph: Open access).

Here, I elaborate on the subject matter based on encyclopedic material that provided me with information about this historical period mentioning that the stick rattle is an instrument used in Buddhist services, which was possibly transformed into *sabayi* of the Uyghurs and Uzbeks in the Islamized western regions after the 10th century (Yuan Bingchang and Mao Jizeng, 1986: 274;



¹ The term stick rattle is derived from the original meaning of xi-stick. Xi-stick is a transliteration of its Chinese name 錫杖 (*xízhàng*). If “xi” is absent, there is no possibility to discuss the similarities with a range of instruments of this type in pronunciation of names and its connection to an onomatopoeic appearance as suggested by the author. Yet, there is a need to clarify that all of these instruments are stick rattles of different length and shape, as well. The pronunciation will be, therefore, only discussed in the context of *xízhàng*.

270). Similar instrument types are found under the names of *syldyrmaq* and *asatayak* among the Kazakhs, the bell ring and the triple ring among the Huis, the bell knife or *halima*-knife among the Manchus, and magic knife among the Zhuangs, Dongs, Yaos, Miaos, Tujias and Hans. The first syllable of *sabayi* or *syldyrmaq* sounds similar to that of *xi*, which has the meaning of ‘rattling’. The stick rattle and those transformations are, so to say, related in form, structure, tuning and name.

What was Islamized in Xinjiang after the 10th century was mainly connected to the religion and politics resulting out of this entire process. The musical culture of the local population was not completely interrupted during this period. Many musical instruments have crossed the fault line between Buddhist and Islamic constructions of civilization. The *zhamunie*, *rewapu*, *daolangrewapu*, *rebabu*, *balangzikuomu*, *kumuriyi* and *kaomuzi* may be mentioned as examples, showing obvious similarities with certain musical instruments of the Silk Road such as the *qiuci-qinhan* pipa. They use different names, but have similar features in form, structure, and tuning. These were most probably originating from musical instruments used by inhabitants along the Silk Road of those ancient times.

The discovery of the remains of the stick rattle *xízhàng* in the Islamized Xinjiang might be another substantial evidence of the historical fact that the musical life was not interrupted or completely changed. That is why I don’t think Kishibe Shigeo’s earlier claim that all the musical instruments of the ancient Silk Road have vanished (Kishibe Shigeo 岸邊成雄, 1973) is correct.

It has been nearly thirty years since I discussed the similarities between the Uyghurs’ *sabayi* and the *xi*-stick rattle in terms of their form, shape, and structure, the correlation between their etymological designations, raising the question of how they crossed the obviously permeable fault line between Buddhist and Islamic civilizations in Central Asia and still maintained their unique form, feature and cultural connotations. Further studies conducted during these years revealed the inherited relationship between instruments of this type. In this conjunction, attention is given to the process of their spread and transformation from Egypt’s sistrum to the stick rattle in the middle ages, the Uyghurs’ *sabayi* and *sachi* further to the Vietnamese *sinh tien* and the Japanese *suzu*. Additional points worth examining referred to the historical thread that the first syllables of a range of similar rattles’ terms show parallels to the name of a sistrum.

LITERATURE REVIEW

There are a number of short writings available about the sistrum. In addition, some pictures exist, all of them are mainly in the public domain. The literature mentioned here is selected since not all writings are accessible, neither physically nor virtually, or regarding their language. Therefore, this is just to introduce a small part of it, which the author finds important.

SISTRUM



FIGURES 2-6: Ancient Egyptian sistrum in various depictions. The first two show examples collected in the New York Metropolitan Museum. (Photographs by Long Fei, 1 August, 2017). In the last three pictures an image of Isis’ head is visible. (Open access, last retrieved 29 April 2020).



FIGURE 7: Roman statue of Isis, first or second century CE. She holds a sistrum and a pitcher of water, although these attributes were added in a seventeenth century renovation. (Photograph provided by courtesy of Carole Raddato: Marble statue of Isis, the goddess holds a situla and sistrum, ritual implements used in her worship, from 117 until 138 AD, found at Hadrian's Villa (Pantanello), Palazzo Nuovo, Capitoline Museums).²

Other encyclopedic literature is found in *The New Grove Dictionary of Music and Musicians*, in the *Sage Encyclopedia Music & Culture*, and in some less prominent collections (Blade, 2005 [1970]; Powne, 1968; von Hornbostel & Sachs, 1914; Yates, 1875). Single articles written about the sistrum come rather from younger authors, such as Timkehet Tefferu who wrote in 2016 about the Ethiopian Sistrum Tsenatsil [ፀፍፀል]. The evolving knowledge from all these writings can be supported with the examples presented in this paper.

The most elaborated and widely applied definition of the sistrum in the 20th century is the following, which is partially taken from *Encyclopedia Britannica* and other works published in the 1990s and in later editions:

“Sistrum (Lat., from GK. seistron: “that which is shaken”) is a type of rattle. Its shape was roughly that of a spur, consisting of a U form with a straight handle protruding from the bottom. The U is transverse by loose-fitting metal rods, which jingle upon being shaken. Frequently small loose discs are fitted to these rods to create additional sound.

The sistrum was especially common in Egyptian cult music, at first in the worship services of Hathor and later in the worship services of her successor Isis. Its function here is usually interpreted as having been apotropaic, that is, as warding off unwanted evil spirits. Egyptologists trace its origin to black Africa where it still appears among certain tribes, as it does also among Coptic Christians. From Egypt, it spread to other Near Eastern civilizations, particularly the Sumerian. It was not at all prominent in Greece but was much used at Rome after Egypt became a Roman province in 30 BC. The cult was at first frowned upon officially but became established with the building of the temple of Isis under Caligula in AD 38. Roman representations of Isis generally showed the sistrum as one of her chief attributes.”

FIGURE 8 (right): Egyptian Bronze sistrum, dated after 850 BC (crossbars and jingles are added later); exhibited in the British Museum, London. Depicted in *Encyclopedia Britannica* (accessible via <https://www.britannica.com/art/sistrum>, last retrieved 16 April, 2020, courtesy of the trustees of the British Museum, London).



Shorter versions of this rather long definition can be found in a number of other encyclopedic works such as that edited by Ruth Midgley “*Musical Instruments of the World*” and some others. The pictures of this musical instrument can be found in many places. For example, as illustrations on other instruments such as on the front board of a lyre unearthed from a grave in Ur dating back to 2450 BC.

² The figure places her weight on her left and moves her left slightly back and to the side. In her right hand she holds a small jug by her side (this object is the product of a restoration) and in her left a sistrum, a musical instrument. Originally an Egyptian goddess, the worship of Isis spread to the Greco-Roman world in the 4th century B.C. after the conquest of Alexander the Great over Egypt. Here the goddess is shown in a long chiton, a typical style of Greek dress. She also wears a mantle that ties over her breasts. A piece of the mantle is used as a veil to cover her head, which is also adorned with a sun disk. The work dates to the first century A.D. From Villa Adriana. capitolini.info/scu00744/. Public domain.

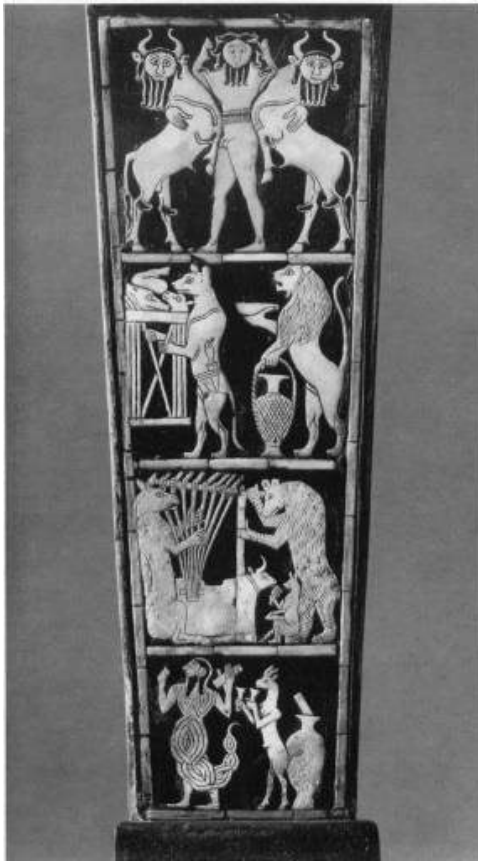

FIGURE 9 (left): The front board of the lyre unearthed from Ur Grave (Photography by VEB Deutscher Verlag für Musik, 1984; public domain; Subhi Anwar Rashid, 1984: 41).

MESOPOTAMIA

The volume *Mesopotamien* (Mesopotamia) was written and compiled by Subhi Anwar Rashid and is a great source of knowledge in this regard. He explains the photo depicted in figure 10 with the following words: “On the third row, counted from the top, of this image [figure 10] is a donkey sitting and playing a large upright lyre, and a standing bear holding its cross rod and a vertical pole respectively with his front paw. The resonant box looks like the shape of a lying bull. A little fox or a jackal sits on the hind paws of the bear, holding a sistrum with one claw and beating something like a drum, a square one or a round one, with the other.” (Subhi Anwar Rashid, 1984: 40).

In short: It is an image of an “animal band” on the front board of a lyre, unearthed from Ur Grave of the first dynasty of Ur Kingdom (about 2450 BC), which indicates that the Sumerians used the sistrum as early as that period.

As Martin Bernal (1987-2006) wrote in his *Black Athena*, “The Greek worship of Isis is a descendant of the Egyptian foundation established there 700 years ago.” The ancient Egyptian worship of Isis had a great influence on that of Demeter in Eleusinian, Greece. Isis is considered as the archetype of Christian Virgin Mary. The earliest name of Paris was Perisis, meaning “the temple of Isis”, according to the medieval literature accessible in the French National Library. The sistrum unearthed in Pompeji is a distinct proof that the ancient Egyptian civilization had a great impact on ancient Greek and Roman civilizations, which can be traced back to the Sumerian culture of Mesopotamia in 2450 BC.



FIGURE 10-11: The sistrum unearthed in Pompeii in the 1st century, Isis’ image is visible on top of its handle in the second picture. (Photograph: Open access).



FIGURE 12: Various coins depicting sistra. (Photographs: Open access).

Images like these were also minted on coins in ancient Greece and Rome. Under the influence of Egypt's hierarchy, the worship of Isis appeared in these countries as well. So far, we have still seen the image of Isis holding a sistrum. It later became one of the motifs of Christian art. Sistra had a symbolic meaning in a number of paintings and pictures such as a fresco by Klimt from the 19th century Vienna.



FIGURE 13: Fresco by Klimt in the 19th century Vienna. (Photograph: courtesy of Chen Bohan); FIGURE 14: Egyptian amulet in the shape of an ankh, 2nd -1st BC. Others were called a *tyet* amulet that was used in the 15th or 14th century BC. The picture is accessible via the ancient world. tumblr.com. The figure 15 shows a *tyet* amulet, also known as Isis-knot. The photograph was donated to Wikimedia Commons as part of a project by the Metropolitan Museum of Art. (Photograph: Open access).

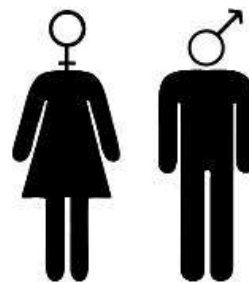

FIGURE 15-16: Ancient Egyptian sistrum with a cross handle; Figure 18: Stylized symbols for female and male. (All depictions are royalty free open access).

Ancient Egyptian images often illustrate Egyptian king holding a sistrum in one hand and a scepter in the other. So does the queen, and the same God respectively holds both sistrum (plural of sistrum) and scepter in both hands. In some images, they are combined to a whole sign consisting of a sacred charm.



FIGURES 17-19: Egyptian king and queen hold the sistrum and scepter in the 1st picture. A god holds the same things in his hands in the second; Figure 21: The sistrum and scepter are combined into a whole sign, the background of which is the sistrum and the scepter in the middle. (All depictions are royalty free open access).

SPECIFIC CHRISTIANITY

The bronze sistrum that was a type of percussion instrument, common in Egypt during the 9th century BC, remained in use along with other musical instruments within the Ethiopian Orthodox Church use to accompany the religious chants for centuries (Teffera, 2016).



FIGURE 20: Photography of an Ethiopian painting by Jahsensie taken on 10 June, 2005. “Peinture éthiopienne sur cuir représentant des prêtres éthiopiens jouant du sistre et du tambour.” (Open access).

Four musicians, two of them each positioned at the drummer’s side, in this image, hold a prayer stick in one hand and shake a sistrum they hold in the other hand. This resembles Egyptian

depictions. The prayer stick is a type of scepter rather than a musical instrument that can be used for structured playing. Probably, the prayer stick and sistrum were later combined into a stick rattle.

In the Metropolitan Museum of New York, there is a long-handled rattle from Rajasthan, India, which is a type of stick rattle.



FIGURES 21-23: The rattle with a long handle, India, unknown time period. (Photographs courtesy of Xiao Mei, taken in the Metropolitan Museum of Art, New York, 2015).

Some scholars point out that this instrument can be used to be catapulted into “trance” state, a psychological state, in which the magician, the sorcerer, or the shaman himself seems to feel "connected with heaven and earth" and "staying in the world of deities" (Blade, 2005; Sachs, 2006). It is rendered as "gods descending to the world" or "gods coming down to earth" in some Chinese ritual practices. Xiao Mei (2016) translated “trance” into 转思 [zhuǎn sī] in Chinese, i.e., with the idea of changing, in order to fit both its sound and meaning, which entails entering into another state of mind. The *sistrum*, *sabayi* or similar musical instruments can also help to trigger trance as any other hallucinogenic drugs do.

Moreover, there is another type of rattle with a long handle, used in pairs in the Syrian Orthodox church located in the Martin Province in Turkey, as I was informally, told. It looks like an intermediate form between a sistrum and a stick rattle, similar to another a specimen found in The Metropolitan Museum of Art, in India.



FIGURE 24: Turkish rattle with a long handle used in pairs. (Screenshot by Long Fei taken from a local documentary in 2010); Figure 23: The Logo of the Syriac Orthodox Church. Visible are various sticks that can carry small rattle elements. Openly accessible via https://www.wikiwand.com/en/Syriac_Orthodox_Church. Reproduced on 10 November, 2018.

THE STICK RATTLE (*xízhàng*)



FIGURE 25: The stick rattle *xízhàng* unearthed at the Famen Temple near Xi'an exhibited in the temple's treasure hall, 2018. (Photography open access).

In the *Dictionary of Buddhism* (Ding Fubao 1987) one finds a description of names for this stick rattle as following:

“Stick rattle (*xízhàng*): Khakkhara (in Sanskrit), one of the eighteen instruments used in Buddhist services. It is called xi-stick, sheng-stick meaning sound stick or ming-stick in Chinese. The rattling sound of the stick rattle is caused through being shaken. It is also named zhi-stick (wisdom stick) or de-stick (morality stick).”

Khakkhara is transliterated into *kaiqilo*, *chiqilo* or *xiqilo* in Chinese, each of which sounding like *sistrum* in Sanskrit. In the following, some sutras are roughly interpreted. Although they are published in several literatures, yet it is impossible to give a specific source of citation. Sutas are well-known short episodes or teaching (pedagogical) stories found in popular books about Buddhism. The main ideas are summarized in English as follows:

The Dedaotideng Sutra of the stick rattle (xízhàng)

Buddha says to a monk, “You ought to accept the stick rattle when it is given to you. The reason is that each Buddha--- either the past, the present or the future --- has one. It is also rendered as *zhi*-stick (wisdom stick) for publicizing the wisdom of Buddhism, and as *de*-stick (morality stick) for doing boundless beneficence. It is the mark of the saint, the sign of the sage and the image of Dharma.

Sutra of Jizo Bodhisattva (Ksitigarbha) – 2

Good deeds come from benevolence. Vows are for saving all human beings. The golden stick rattle in the hand can open the gate of hell, the bright pearl in the hand can illuminate the entire universe. In the wisdom sound and auspicious clouds, do immeasurable indisputable merits and virtues for the suffering people in the world. Cherish great mercy and great wishes, and great holiness and great kindness.

The Picture Story of Mulian Saving Mother in Hades, Vol. 1

Buddha says: “I will give you my *xi*-stick rattle in case of emergency. It can be used to drive out varieties of disasters and difficulties for you. The gate of hell should be opened so long as ye repeat my name continuously.”...King of Jizo asks: “Why did you open the gate?” Mulian replies: “Who else could have done that except me? Buddha has given me something for that.” The king asks again: “What's that?” The answer is: “It is a stick rattle with twelve rings.”

Shisonglv (Sarvastivada-vinaya)

What the stick rattle's mana is, Buddha stays in the cold woods, where poisonous snakes have appeared frequently and bitten the monks. Buddha says: “You should make a stick to create sound, which can drive them away.” That is named magic stick.

Sifenlv (Dharmagupta Vinaya)

Walking along the road, several monks see snakes, maggots and centipedes around. Frightened, they tell Buddha about it. He replies: “Drive them away by shaking *xi*-stick rattle to create sound.”

Petunia Chores

To beg for food, a Buddhist monk knocks at a door with his fist and the family in the house is disturbed and then complains: “What did ye want to do?” Silent, the monk has nothing to say. Buddha says: “You shouldn't have done that but make a *xi*-stick rattle.” The monk does not understand, then Buddha explains: “Fasten a ring as round as a dish to the top of a stick and fit to it a number of small loose rings. Shake it to create sound and that will call them out.”

...Once at an unbeliever's gate, he shakes his *xi*-stick rattle so many times that he feels tired, still nobody comes out and answers him. Buddha says: “You shouldn't have done that so long but twice or thrice, then leave there if nobody answers.”

Fundamental Chores

To beg for food, a Buddhist monk enters into an elder's house and then he is ridiculed and slandered by that family. Buddha says: “Make something to create sound to make them hear.” Then he makes a stick rattle.

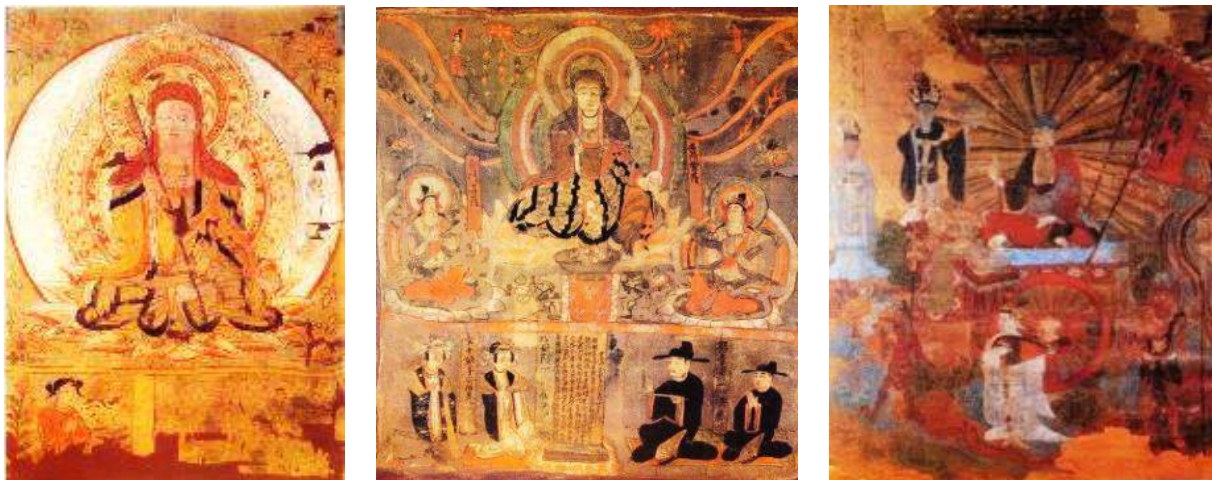

FIGURE 26-28: In the first two pictures, King of Jizo holds a stick rattle over his right shoulder. In the third, Tejaprabha Buddha has a stick rattle in his hand. Katharine Schlesinger (1921) calls the stick rattle in this picture just *sistrum* in her *Annotations to Musical Instruments in the Stein Collection*. Public domain.

The Buddhist monk's traveling around with a stick rattle is known as flying-*xi* or patrolling-*xi* and his staying somewhere as hanging-*xi* or staying-*xi*. For the convenience of those who travel across the desert, carrying only a bowl and a stick rattle with them, a type of small stick rattle has emerged, which seems to be what is between the stick rattle and *sabayi*.



FIGURE 29: A shorter traditional stick rattle (Photography by courtesy of Akiko Ban); FIGURE 30: A modern stick rattle distributed via online shops (accessible via 【楽天市場】 【密教法具 寺院用仏具】 鳴金錫杖(真鍮柄) 小型 長さ 25cm 【お盆用品 仏具 お彼岸 寺院仏具 京都製 国産品 通販 楽天】 : 仏壇屋 滝田商店. Last retrieved 1 May, 2020; FIGURE 31: Buddha's teaching. A long stick rattle is seen on the left of his seat hold by a close follower. Accessible via <https://culture.followcn.com/2017/01/10/influence-of-buddhism-in-ancient-chinese-arts/>, last retrieved 1 May, 2020.



FIGURE 32: A'nan begs for Alms with a small stick rattle and a bowl in his hands. This picture is on the east side of the southern wall of the main room, No.85in the Mogao Cave, and it was drawn possibly during the Late Tang Dynasty (photography by the author); FIGURE 33: Buddhist teaching. The main figure is holding a stick rattle in the right hand. Accessible via https://www.kunst-fuer-alle.de/media_kunst/img/36/g/36_157742~chinesische-malerei_budd-hist-banner-depicting-dizang-and-the-six-roads-to-rebirth-from-dunhuang.jpg, last retrieved 1 May, 2020.

The Dictionary of Buddhist Light

The small stick rattle is quite similar to the Chinese Uyghurs' *sabayi* in form and structure. The Japanese Buddhists of Tiantai and Zhenyan sects would be shaking it while chanting in their Buddhist services. This is one of the four elements of important Buddhist rituals. What they are chanting on such an occasion is called *xízhàng* specially.

SUZU, SABAYI, SYLDYRMAQ, XISA AND MAGIC KNIFE

There is a similar instrument *suzu*, also known as the witch bell, i.e. 神樂すず in Japan.

FIGURE 34: *Suzu*, exhibited in Peter the Great Museum of Anthropology and Ethnology in St. Petersburg. (Photography by courtesy of Liu Guiteng, St. Petersburg, 2019.)

Some important information is contributed to the Dictionary of Chinese Music (1984). Here, we find the following description:

“Sabayi is a type of rattle of the Chinese Uyghurs in various shapes. Originally, it consisted of a pair of ram horns with a number of loose-fitting iron rings. Nowadays, it is made up of two pieces of side-by-side positioned hardwood sticks, fastened to each other in the middle, where two big iron are rings with a number of loose-fitting small iron rings. In a performance, the player holds it with the right hand, shaking it or hitting it against the shoulders or the other hand to create sound. Usually it is operated as the musical accompaniment to dances.”



In Wan Tongshu’s work (1986) “The Musical Instruments of the Uyghur”, there is a short introduction referring to sabayi. It is written that in the past, some people, who were suffering in life and extremely disgusted with the world, used to be wandering about, hair scattered, in graveyards or wastelands, singing songs and shaking sabayi in order to give vent to their sorrow and anger. Beggars would shake *sabayi* in accompaniment to chanting maqamat, begging for alms at the roadside. In addition, it was one of the instruments, the *Bakshi* used to drive evil spirits out of patients.



FIGURE 35-37: Different shapes of sabayi and people shake it, chanting along (All photographs open access, Figure 35 as depicted in “The Chinese Musical Instrument Atlas” (1987: 196).

These should be successors of the Buddhist monk incognito, staying marginalized in the Islamized Western Regions. What they did for begging was entirely in the style of the previous Buddhists. Bakshi exorcises evil spirits with sabayi as Buddhists do it with the stick rattle. They have the same religious connotation.

Bakshi, also known as *ashiq*, is classified to the Sufi of Islam. In fact, what some Uyghurs have actually adopted is a custom that may have its roots in Buddhist rather than their Shamanist traditions. However, there are other kinds of use of the sabayi-type among male Muslim pilgrims, evident in performance practices of South and Southeast Asia such as Dabus.

An *ashiq* is also known as keletair, meaning the beggar, of whom the one with high accomplishment in Buddhist knowledge and practice is known as Dervish. The wandering

Buddhist monk is also called Dervish, who travels out begging for alms, in the robe of patches, with a *xi*-stick rattle or a Jingang pestle in one hand and a bowl in the other. These two kinds of Dervish have the same connotation in culture.

The original stupa was a Buddhist shrine dedicated to the storage of the eminent monk's relic while Mazar Ashq worships is the holy land or the Holy sepulchre. They both contain the same cultural connotation. The Islamic holy land is usually the ancient Buddhist shrine in Xinjiang. The tradition of prayer flags hanging up over Tibetan Buddhist cairns seems to remain on some Mazars in the fields.

The worship of Mazar differs from the Islam's five-time-a-day- lesson and is more like going to the Buddhist temple fair. Some Mazars are in memory of those who could enable infertile women to have children and some others of those who could exorcise evil spirits and cure diseases. They both are similar to the Buddhist worship of Herbalist Buddha (Bhaisajyaguru) and King of Jizo (Ksitigarbha).

The Records of the Barbarian States in the Western Regions (according to the annotator Zhōu Liánkuān, 2000³)

Some people have abandoned their families and disregarded their businesses. Away from normal life, they are unkempt and barefoot, in tatters or sheepskin, holding a strange stick, wearing a chain of bones of ox or sheep, looking extremely weird. They have been walking all the way begging for alms in cold and hot weather, and would be muttering something when meeting with people, showing how pitiful they are as if life was so hard for them to survive. They would gather at the cemetery and live in caves, claiming and doing ascetic practices. This is called Dilimishi. In order to free oneself from the pain of the soul.

“Dilimishi should be Tilmidh in Arabic, which is what the authentic Buddhist called the heretic believer originally. The latter willingly endures physical pain, living an ascetic life so as to liberate himself from the pain of spirit.” (Zhōngwài jiāotōng shǐjì cóngkān běn, 2000: 87). Zhōu Liánkuān wrote this in his *Annotations* to the “*Records*” mentioned above and created by Chen Cheng and Li Si in the Ming Dynasty and printed publicly in 1991. The cemetery here should refer to Mazar. All these are deeply ingrained within the Buddhist civilization.

It is still unknown whether this strange stick is a stick rattle *xízhàng* in a changed shape. Maybe, it is a transitional form between stick rattle *xízhàng* and the *sabayi*.

The stick rattle was a fashionable instrument while Buddhist civilization flourished in ancient Western Regions, but it had to go incognito after the introduction of Islam in the 10th century. In this situation, the small *xi*-stick rattle continued to be popular among the people in the name of *sabayi*. It does not appear to be fortuitous that the first syllable of its name sounds similar to that of a sistrum or a *xi*-stick rattle. That is the reason why the *xi*-stick rattle has transformed into *sabayi*.

Grand Exposition of Chinese Music Culture (2001, Beijing)

Syldyrmaq is a type of percussion idiophone of the Kazakh people. Its name is transliterated from Kazakh, meaning *voice of owls*, consisting of a piece of wooden board with six strings of

³ Zhou Liankuan (10 February, 1905 -17 December 1998) is a library scientist, bibliographer, archivist, historical geographer, one of the professors and founder of the Information Management Department at Sun Yat-sen University. Formerly known as Zhou Zixian and Zhou Zhao (aliases: Kuzhuzhaizhu, Dugong, Kuany). He graduated from Wuchang Wenhua Library College in 1930 and later became director of the Shanghai Municipal Library, professor at Sun Yat-sen University, at the Department of Library Science. He annotated and proofread 陈诚、李暹 (著), 周连宽 (校. 1991 年, 《西域行程记·西域番国志》(中外交通史丛书), 北京: 中华书局 in the year 2000.

metal discs fastened on it and some owl feathers fixed to the upper end of the board as an ornament. During the performance, the player holds its handle, shaking it to create sound in the rhythm of the music. It is used as the musical accompaniment to singing and dancing for entertainment, common in Northern Xinjiang.



FIGURE 38: Syldyrmaq (source provided by the author: *Great Dictionary of Chinese Musical Instruments*. 2002. Beijing: Yue Sheng: 610).

It does not seem incidental that its first syllable sounds similar to that of the sistrum or the *xi*-stick rattle, for they are similar in form, structure and function. Classified finely by the way of playing, *syldyrmaq* should belong to a rattle type rather than a percussion instrument because it is shaken not struck.



FIGURE 39: Xisa: An apron belt depicted in “The Chinese Musical Instrument Atlas” (1987: 186); FIGURE 40: An apron belt with rattle elements and small bells as found in Nepal among shamans. (Photography by courtesy of David Alan, accessible via <https://thedavidalancollection.com/2018/08/08/musical-instruments-from-japan-indonesia-nepal-sacred-secular-and-unusual-pieces/>, last accessed 1 May, 2020).

Another information features Yue Sheng’s work (1988) titled “The Musical Instruments of the Minorities in China”. For example, He suggests the following: **Xisa** is a type of percussion instrument, which is also known as waist bell and called shaman bell in Manchu language, used by the Manchus, Hans, Daur and Ewenkis, common in such parts of China as Liaoning, Jilin, Heilongjiang and the eastern Inner Mongolia Autonomous Region. Made of copper, iron or alloys, it consists of thirty-two small trumpets and three small bells, fixed alternately on a piece of ox hide or horsehide, 50 cm long and 20 cm wide. Each trumpet, 15 cm long, with the upper diam. 2.5 cm and the lower, 4 cm, has a small ring fixed to its tip. All of these rattle vessels are fastened on the rear of a belt made of ox hide with 120 cm length and 7 cm width. The whole

stuff weighs more than 15 kg. The trumpets and bells create sound when waved, swung, paused, swayed or shaken, mostly used together with other instruments in the performance...much used by the Daur, Mongolians and Hans in the cult, exorcism and other services.

Xisa is different from the sistrum, stick rattle, or sabayi through its form and structure but its function has striking similarities with the two music instruments. It does not seem unexpected that the former's first syllable sounds similar to the latter. Since it is finely classified through its way of playing, *xisa* is undoubtedly a rattle.

The Dictionary of Chinese Musical Instruments (1999, Beijing)

Magic knife is a type of rattle idiophone used by the Manchus, Zhuangs, Miaos, Yaos, Dongs, Tujias and Hans, called hama-knife or bell knife in Manchu language and saman knife in Northeast China. Made of copper or iron, generally it consists of a pair of scissors with a number of small loose iron bells fitted to the handles, common in such regions as Liaoning, Jilin, Heilongjiang, Guangxi, Guizhou, Hunan and Hubei etc... In addition to this, there is another type of magic knife in other China regions, for instance, in Guangxi, Guizhou, Hunan and Anhui. Here, the magic knife is a knife attached to a big iron ring at the end of the handle along with a number of small loose iron rings fitted to the big ring.

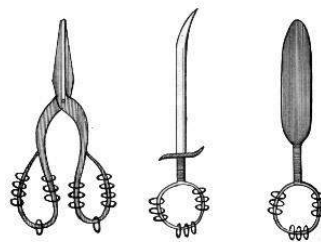

FIGURE 41: Magic knife in various shapes. (Drawing royalty-free open source, expired webpage).

There is a type of *luan*-bell knife mentioned in *The Book of Songs*, which is similar to magic knife in form and structure except that the former has bells and the latter has rings. The poem *Bless people with a bumper harvest each year, and a good health and long life* is illustrative of its connection with religious cult. There are certain similarities between Chinese *luan*-bell knife



and Egyptian sistrum in form, structure and function. Thus, a question remains as to whether it is a coincidence or mutual influence. When it comes to time, the *luan*-bell knife appeared later than sistrum. Could it be that the *luan*-bell knife was created with the inspiration from sistrum? According to the claim “Chinese civilization originated from ancient Egyptian” (Luo Ling-jie, 2012; Liu Guang-bao, 2018), we might find out the answer to this question.

As interpreted by Xiao Mei, shaking bells upwards implies inviting gods or ancestors while vibrating rings (or discs of iron or gourd) downwards implies warding off or exorcising evil spirits. In the Zhou Period in Chinese history, the *luan*-bell knife with only bells had only one function and nowadays the magic knife with both bells and rings has both functions.

FIGURE 42: Magic knife with rings, probably of the Iu Mien (Yao) shamans living in China. (Photography by courtesy of Zena Kruzick, accessible via http://zena-kruzick.com/asian-tribalart/asian_tribal_art_dagger_yao-2605_details.htm, last accessed 1 May, 2020).

SACHI, SINH TIEN, PEACE-DRUM

The Sachi is common in Zhejiang and Fujian Provinces of China, of which the first syllable *sa* sounds quite similar to the pronunciation of a sistrum, and has similar function in culture to *xi*-stick rattle and *sabayi*. Beggars would use it when singing something to beg for alms.

As described in *An Illustrated Encyclopedia of Chinese Music History* [Liu & Quan, 1988], it is a thin bamboo pole with some holes in it and a number of loose copper coins fitted into these holes by fixing them with an iron rod.



FIGURES 43-44: Sachi in the first picture and in the second, a girl plays a *dalianxiang*, the other shape of sachi (both depictions open access, expired website).

Records on Music in 'The Draft History of the Qing Dynasty'

Sinh tien (in Vietnamese) is a musical instrument consisting of three main parts often used by beggars in the Chinese context. The three parts are slabs of sandalwood, to one of which fitted are several copper coins. The back of the second part is serrated and the third has a jagged edge. The player holds the first two slabs with the left hand, clapping them against one another. Consequently, the coins create a rattling sound. Simultaneously, with the right hand, the musician pulls the third part up and down using its jagged edge to scrape the back of the second part with the aim at creating a scraping sound. This instrument is widely described in Vietnamese (Tran Van Khe, 1959) and other literature (Jähnichen, 2019).

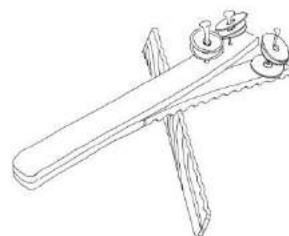

FIGURE 45: Sinh tien is a combined idiophone with rattle elements and scraping surface. It is used as accompaniment to songs performed by beggars in the Chinese context and in Central Vietnamese music traditions. (Drawing by courtesy of Wang Lei).

The *taiping gu* (a peace drum) is an iron hoop covered with leather. A wooden handle with a big ring is fixed on its end that may contain further smaller metal rings. Since its form, structure

and religious function are concerned, the peace drum seems to be a secularized drum of shamans, yet there is no definite proof for it.



FIGURE 46: A *taiping gu* (according to the Chinese Musical Instrument Atlas, 1987: 141); **FIGURE 47:** The Mongolian shaman drum, exhibited in Denmark National Museum, Copenhagen (Photography by courtesy of Liu Guiteng, July 2014); **FIGURE 48:** The shamans are in divination using the shaman drum. Exhibited as ‘Shamaner og andermanere/p.3’ (Photography by courtesy of Liu Guiteng, July 2014); **FIGURE 49:** A Peaceful Spring Market (Picture by courtesy of Ding Guanpeng, 1988).

There is a popular rhyme coming to my mind:

Iron rings ringing and drums pounding,
Crowds dancing as the old year leaving.
Air of peace and happiness everywhere,
Kangqu and *Jirang* praising the same thing.

This is a ballad dating back into the Qing Dynasty, which is up to present days a true and vivid portrayal of the scene in the second picture. *Kangqu* and *Jirang* are folk songs praising the sagacious monarch appointing talents to important positions and praying for a great harmony in the world of peace and safety.

SOME BRIEF ANALYSES

ETYMOLOGY/ PRONUNCIATION OF NAMES

The first syllables sound respectively similar to *si*, *xi*, *sa* or *se*, which appear to be connected to the pronunciation of the sistrum that had been found in Egypt. The named syllables are believed to be onomatopoeia of the rattling sound when snakes are seeking a spouse⁴. In Darwin’s book

⁴ Snakes cannot hear acoustically. The rattling of their dried-out tail ends is rather to warn animals that can hear them than calling for a mate that definitely cannot hear the rattling sound. Although snakes may have a very

titled “The Descent of Man, and Selection in Relation to Sex”, rattle snakes were mentioned. He said that when two rattle snakes meet, they will “entwine into a ball with their heads standing up straight, creating jiajia- sound intermittently ... then begin copulating.” (Darwin 1983 [1871]: 544). It can be concluded that human beings may associate this specific sound with copulating behaviour. The given description above may remind to the copulating of Fuxi and Nuwa, the ancestor gods in some Chinese myths, of which an image of copulating of Fuxi and Nuwa is provided in a stone relief of the Han Dynasty inside the Wu Liang Shrine. It was depicted by Zhu Xilu and printed in Shandong Fine Arts Press, 1986, on page 50.

In Xiao Mei's (2013) “A Study of Spiritual Music in the Context of Institutionalized Sound [响器制度下的“巫乐”研究]”, where the role of percussive music as part of the institutionalized spirituality is investigated, the *sala*-hoop, used by the *sangpa* of the *Naxis* in the Lijiang area, is the onomatopoeia of the sound its iron discs create when they are shaken. And the *xicer* in her article, the other name of a ring knife of the *Yis*, is the onomatopoeia of the rustling its iron discs create when shaken, which is even more similar to the pronunciation of the Egyptian sistrum.

FORM, STRUCTURE, AND SOUND PRODUCTION

Each of these instruments contains strings of metal rings, bells, discs, gourd discs or copper coins, which create a rapid succession of cracking and complex sound. This is the property of many simple rattles, musical instruments, and ritual tools used in religious services.

CULTURAL FUNCTION

The instruments, which can simulate frogs croaking during a tropical rainy season, are connected to praying for rain, and those that can simulate fertility.

In the world, Gods, for instance, *Isis*, the Herbalist Buddha or the King of *Jizo* as well as sorcerers such as shamans, witches, *ashiqs* or *bakshis*, would use a sistrum, a stick rattle or a similar instrument while praying for children, for rainmaking, for peace and safety. Furthermore, these instruments are sounded for curing diseases and for longevity. They are also played to ward off evil spirits and plagues, and to frighten away poisonous insects. All these rituals belong to the specific world views that are attached to the importance of reproduction in early times of humankind.

RELIGIOUS THEMES

Wherever they are, in Egypt, Greece, India or China, they all involve fertility, death, reincarnation, eternal life through death, and the function of triggering trance, in which people seem to feel themselves connected with heaven and earth, deities or ancestors.

Those in charge of life and death are respectively *Isis* and *Osiris* (king of hell) in an ancient Egyptian myth, *Dionysus* (*Bacchus*) and *Demeter* (queen of hell) in an ancient Greek myth, and the Herbalist Buddha (*Bhaisajyaguru*) and the King of *Jizo* (*Ksitigarbha*) in Indian Buddhism. *Shiva* in Hinduism takes charge of both.

The ancient Egyptian sistrum and its connotations in religious and magical events are the model of stick rattles, among them the *xízhàng*. Perhaps, that is why scholars like Katharine Schlesinger, who annotated Stein's *Serindia*, and some oriental Buddhists called the *xízhàng* just sistrum directly and put them in the same category.

With Buddhism entering China, the stick rattle *xízhàng* and its connotation in religious and

well-trained sense of feeling vibrations (Knight, 2012), this interpretation is based on a mistake found in very early biologist writings, also of Charles Darwin (1871/1983) himself.

magical rituals have spread widely into the Western regions and the hinterland of China as well, from which again derived many other rattle types, musical instruments, and ritual tools in sacred services.

ADDITIONALLY: THE BELL STICK

There are also the remains of the *xízhàng* stick rattle in the West, which can be seen in the so-called bell stick, also known as Turkish Crescent or Chinese Pavilion. It is a type of stick rattle, yet it is not exactly the same as described above. The former has bells jingling when shaken, whereas the latter has iron rings that rustle when stroked. As far as the form and structure in general are concerned, there should be a certain relationship between the bell and the stick rattles with regard to their origin stick rattle.



FIGURE 50: A bell stick, also called Turkish crescent or Chinese pavilion. Soldier of the Music of the French Foreign Legion holding the "Jingling Johnny" during the celebrations of Bastille Day 2008 in Paris. (Photography by courtesy of Nguyen Marie-Lan).

The Turkish Crescent is supposed to be a stick rattle with an ornamental Turkish Crescent, the symbol of Islamic civilization, in the Islamic areas whereas the Chinese pavilion, generally having a conical hat at the top, obviously indicates its relation to the Chinese Buddhist stick rattle.

The bell stick was known in West Asia and Europe from the 16th century onwards and it was used mainly in military orchestras. As such, it became an important instrument in the Janissary band and then the British military bands adopted it in the late 18th century.

Berlioz used this instrument in his *Funeral and Triumphal Symphony* (OP.15). His 'dream' ensemble of 467 instrumentalists included four pavilions chinois among the 53 percussion instruments.

(This paper was translated by Yi Kai and Gisa Jähnichen from a revised and partly extended and corrected version of Long Fei's *Sistrum • Xi-stick • Sabay*, initially written in Chinese and originally published in the Academic Journal *Ritual Soundscapes*, December, 2013: 28-56.)

REFERENCES

- Bernal, Martin. 1987, 1991, and 2006. *Black Athena: The Afroasiatic Roots of Classical Civilization*. New Brunswick: Rutgers University Press.
- Blade, James. 2005 (first published in 1970). *Percussion Instruments and their History*. Revised Edition. Westport: The Bold Strummer.
- Chen Cheng and Li Siang. 1991 [Ming Dynasty]. *Series of Historical Records of Chinese and Foreign Transportation* [西域行程记 西域番国志 咸宾录——中外交通史籍丛刊]. Beijing: Zhonghua Book Company.
- Darwin, Charles. 1871. *The Descent of Man, and Selection in Relation to Sex*. 1 (1st ed. in Chinese translation from 1983). London: John Murray.
- Ding Fubao. 1987. *Cultural Relics*. Beijing: Beijing Press, 1362.
- Great Dictionary of Chinese Musical Instruments*. 2002. Beijing: Yue Sheng.
- Halén, Harry and Bent Lerbæk Pedersen. 1993. *C.G. Mannerheim's Chinese Pantheon*. Helsinki: Finno-Ugrian Society.
- Heise, Birgit. 2002. Membranophone und Idiophone. Europäische Schlag- und Friktionsinstrumente. Musikinstrumenten-Museum der Universität Leipzig. Katalog, 231.

- Hornbostel, Erich Moritz von and Curt Sachs. 1914. Systematik der Musikinstrumente: Ein Versuch. *Zeitschrift für Ethnologie*, 46 (4-5): 553-90.
- Jähnichen, Gisa. 2019. "Idiophones: Scraped Instruments". *The SAGE International Encyclopedia of Music and Culture*. Edited by Janet Sturman. London: SAGE Publishing, 1135-1138.
- Kebede, Ashenafi. 1982. *Roots of Black Music: The Vocal, Instrumental, and Dance Heritage of Africa and Black America*. Tallahassee: Ethius.
- Kishibe Shigeo 岸邊成雄. 1973. Tangdai yinyue shi de yanjiu 唐代音樂史的研究. Taipei: Taiwan Zhonghua Publishing House [Japanese original: Tōdai ongaku no rekishiteki kenkyū. Gakusei hen. 唐代音樂の歴史的研究. 樂制篇. 1960–1961. Tōkyō: Tōkyō daigaku.].
- Knight, Kathryn. 2012. Snakes Hear Through Skull Vibration. *Journal of Experimental Biology*, 215: ii. DOI: 10.1242/jeb.069104.
- Long Fei 隄菲. 1991. *Materials of Chinese Music History in Dunhuang Frescoes*. Lanzhou: Dunhuang Literature and Art Press, 446-450.
- Midgley Ruth, ed. 1976. *Musical Instruments of the World. The First and Only Comprehensive Illustrated Encyclopedia of Its Kind*. New York & London: Paddington Press.
- Powne, Michael. 1968. *Ethiopian Music an Introduction: A Survey of Ecclesiastical and Secular Ethiopian Music and Instruments*, Oxford University Press. London
- Sachs, Curt. 2006. *The History of Musical Instruments*. Unabridged re-publication of the work originally published in 1914. New York Dover Publications.
- Schlesinger, Katharine. 1921. Notes on Musical Instruments Represented in the Stein Collection. Aurel Stein, Serindra, *Detailed Report of Explorations in Central Asia and Westernmost China*, Oxford, I ~ Z I 1(4): 67-69.
- Zhu Xilu. 1986. *Photography of Fuxi and Nuwa Copulating, Stone Relief of the Han Dynasty inside the Wu Liang Shrine*. Shandong: Shandong Fine Arts Press, 50.
- Subhi Anwar Rashid. 1984. Mesopotamien. *Musikgeschichte in Bildern, Bd. II, Musik des Altertums/Lieferung 2*. Leipzig: Deutscher Verlag für Musik.
- Timkehet Teffera. 2016. The Ethiopian Sistrum Tsenatsil [ፀናፀል]. Unpublished ms. Accessible via https://www.academia.edu/25634894/Timkehet_Teffera_2016_.The_Ethiopian_Sistrum_Tsenatsil_%E1%8D%85%E1%8A%93%E1%8D%85%E1%88%8D_.
- Xiao Mei, Kong Chongjing, and Zhang Zhenrui, 2019. Shaanbei Pipa Shuoshu (Pipa Storytelling of Shaanbei) from the Perspective of Inner Asia. *Plucked Lutes of the Silk Road*. Edited by Lawrence J. Witzleben and Xiao Mei. Shanghai: Shanghai Conservatory of Music Press, 22-48.
- Xiao Mei. 2013. *A Study of Spiritual Music in the Context of Institutionalized Sound* [响器制度下的“巫乐”研究]. *National Arts*, 2: 28-37.
- Yates, James. 1875. Sistrum. *A Dictionary of Greek and Roman Antiquities* William Smith, D.C.L., LL.D. John Murray, London. 1875: 1046 (Online accessible: http://penelope.uchicago.edu/Thayer/E/Roman/Texts/secondary/SMIGRA*/Sistrum.html; last retrieved 25 May, 2016)
- Yuan Bingchang and Mao Jizeng. 1986. *Zhongguo Shaoshu Minzu Yueqi Zhi [The Musical Instruments of the Chinese National Minorities: A Dictionary]*. Beijing: Xin Shijie Chuban She [The New World Press].
- Zhongguo Yinyue Cidian*. 1984. [*Dictionary of Chinese Music*]. Beijing: Folk Music Publishing.
- Zhongguo yinyue tuzhi* [Chinese Musical Instrument Atlas]. 1987. Beijing: Qinggongya Publishing.
- Zhōngwài jiāotōng shǐjì cóngkān běn*. 2000. {Chen Cheng and Li Siang. N.d. (Ming Dynasty). *Series of Historical Records of Chinese and Foreign Transportation*. Proofread and annotated by Zhou Liankuan}. Beijing: Zhonghua Book Company.

SOME THOUGHTS ABOUT PROFESSIONAL FIELDS OF ETHNOMUSICOLOGISTS IN MUSEUMS

Matthias Lewy

Lucerne University of Applied Sciences and Arts, contact: matthiaslewy@gmail.com

Abstract

This is a short essay introducing some thoughts the professional fields of ethnomusicologists working within an ethnographic museum. It is of utmost importance to consider the growing responsibility of any kind of musicologists in the context of a wider presentation of historical facts and social relationships that are the contents of exhibitions in museums. This short report reviews some basic ideas and tries to instigate discussions.

Keywords

Ethnomusicology, ethnographic museum policies, professionalism, de-colonization, holistic sound experiences

The well-known professional fields of ethnologists and ethnomusicologists in the museum context can be differentiated into archive work and the curating practice regarding the displays of objects and facts. For a long time, the first area was primarily reserved for the activities of collecting and documenting objects, including sound objects. Compared to the “cultures of origin”, the argument of “preservation” was spread, combined with one-sided and therefore colonial ideas about “superiority through technology” as seen in ways how storage and restoration is handled. These is only one of the many reasons how European scholars and museologists constructed their kind of history discourse (Said, 1978) of cultural or collective “non-European” groups, which point towards Descola mentioning the human/non-human domain (Descola, 2005). The second field of work, the exhibition, has the main task of “conveying” these “collections” to a larger audience within Europe.

However, when considering new challenges of professional fields of ethnomusicologists, the integration and connection of sound archives to ethnological museums must be taken into account. On the one hand, the Berlin Phonogram Archive stores 150,000 recordings from all over the world (Simon, 2000) is part of the Ethnological Museum of the Prussian Cultural Heritage Foundation (Stiftung Preussischer Kulturbesitz). The CREM-CNRS (Centre de Recherche en Ethnomusicologie) Archive with 57,000 sound documents can be found in Paris and belongs to the Musée de l'Homme. The Ethnographic Museum in Geneva (Musée d'ethnographie de Genève/ MEG) owns a sound archive with 15,500 recordings. The Vienna Phonogram Archive, on the other hand, is not linked to a museum with 75,000 individual recordings, as it is an independent institute of the Austrian Academy of Sciences (Kraus and Lewy, 2019: 186-187).

The questions of integration are important insofar as, for example, indigenous ontologies are becoming increasingly important in the process of decolonization. One newly established focus of attention aims at overcoming the separation of “material and immaterial objects”, on which the European colonial matrix based on previously. This can still be recognized when reflecting on the historical process of archiving, since collections were subdivided according to these criteria in the last century. All “material” objects were safely stored in the ethnological museum's collections while all “immaterial” objects, like sound recordings, were

placed at phonogram archives. Interacting with representatives from indigenous communities in the archive of the museum shows how different the perception with the stored objects is. Invited members of indigenous communities, as could be observed, started immediately to sing or to do other performances when confronted with their “cultural objects” in these archives. Thus, overcoming the colonial matrix means not only reorganizing the archives as it is highly recommendable according to analyses and in terms of material culture (Guzmán and Villegas, 2018: 143), but also the integration of the “immaterial culture” into this ontological unit, which are then often those associated sound recordings. For this purpose, performance rooms in ethnographic museums and their related sound archives will necessarily be set up in order to enable precisely that ontological unity of material and immaterial objects which are often living entities from perceptive traditions that still exist and are practiced by these indigenous people (Lewy, 2018a; Lambos and Lewy, 2019).

These new tasks are also to be transferred to some exhibition concepts, because the perception of these ontological units forms one side of the coin. The other side is the individual work to accept this perception as a given certainty, and, furthermore, to translate and communicate this certainty of perceptive traditions of indigenous practices.

It needs to be mentioned that sound ontologies and trans-specific communication can be and is often built on the bias of performative expressions, i.e. the communication between singers and the physical objects. So, these interactions show clearly a very specific certainty about perception and the mode of existence for many people. Used academic notions and practices are often not sufficient or simply outdated. Therefore, it is one task of ethnomusicologists to underline that there is certainty or that people are certain to communicate with a wide variety of entities and that many non-human entities communicate and interact within human and non-human collective groups. Mainly, these interactions and communications are audible and are practiced through music and/or other formalized sound.

The acceptance of an ontological unit plays a significant role in current collections of institutionalized archives, which is also often seen as the establishment of “cemeteries of objects” (Lewy, 2020). In institutions this is a remarkable thought, in particular when the repatriation of any kind of object or entity stored in a museum storage or put at display is impossible, i.e. due to ontological reasons (Hatoum, 2015; Lewy, 2017).

Translating those processes of archive work into the exhibition spaces also appears as a new or different field of recent ethnomusicology, which is not easy to understand, as the exhibition spaces are largely reserved for classical curatorship of material culture, even if an enhanced process of rethinking and the integration of ethnomusicological works is recently underway. However, in standard exhibition areas, music/sound can still be found very strictly separated from related “physical objects” under the premise of ontological units, and it is then the moment that artists rather than ethnomusicologists are going to fight the “colonial matrix” in ethnographic museums.

However, ethnomusicologists should see this handy stereotyping as a challenge to their subject rather than to build walls separating their ideas from Western art expressions. In addition to some great advantages of often long-term cooperation with source communities that ethnomusicologists experience, the challenge lies in translating musicological and sound research for an exhibition area and finding new or derivative formats, a process, which should also be included in university trainings such as the handling of digital audio work stations within programs. As an example, I would like to point towards the transformation of research results into sound narratives, which I developed together with Bernd Brabec de Mori for various exhibitions and CD productions (Seeger, 2017).

Elsewhere, I suggested the notion of SCIENCE—SOUND —COMPOSING (Lewy, 2015, 2018b), which is certainly open to discussion. There, to say it in short, the concept of sound stories bases on narrative structures of myths and practices among indigenous Amazonian groups of people, which also operate within the ontological unity of “material/immaterial culture”. Some translations consist mainly of developing plots whose fiction content refers to Geertz's definition of FICTIO in the sense of its original meaning as “something made” (Geertz, 1987: 23).

The considerations and examples listed here are only the first very small steps that are to be understood as a suggestion for ethnomusicological subjects to get involved with the museum as an area in order to open sustainable music research results and practice knowledge exchange to the widest possible audience.

REFERENCES

- Descola, Philippe. 2005. *Par-delà nature et culture*. Paris: Gallimard.
- Geertz, Clifford. 1987. *Dichte Beschreibung: Beiträge zum Verstehen kultureller Systeme*. Frankfurt a.M.: Suhrkamp.
- Guzmán, Diana and Orlando Villegas 2014. Workshop 23 July, 2014. Accessible via <https://blog.uni-koeln.de/gssc-humboldt/schlafende-objekte/>. Last accessed 27 May, 2020.
- Haas, Richard, Gaudencio Moreno Muñoz, and María Morera Muñoz. 2018. Las colecciones del alto río Negro en el Ethnologisches Museum de Berlín: aproximaciones recientes a una colección antigua. *Objetos como testigos del contacto cultural. Perspectivas interculturales de la historia y del presente de las poblaciones indígenas del alto río Negro (Brasil/Colombia)*. *Estudios Indiana*, 11. Edited by Michael Kraus, Ernst Halbmayer, and Ingrid Kummels. Berlin: Gebr. Mann Verlag, 135–154.
- Hatoum, Rainer. 2015. Navajo-Zeremoniallieder im Mediensog: Herausforderungen eines kollaborativen Forschungsprojekts zwischen dem Ethnologischen Museum in Berlin und der Navajo Nation, pp. 223–40 in *Handbuch der Medienethnographie*, C. Bender and M. Zillinger (eds.). Berlin: Reimer Verlag.
- Kraus, Michael, and Matthias Lewy. 2019. *Audiovisuelle Sammlungen: zum Umgang mit Bild und Ton*, pp. 186-203 in *Museumsethnologie. Ein Einführung, Theorien, Debatten, Praktiken*. Edited by I. Edenheiser and L. Förster. Berlin: Reimer Verlag.
- Lambos, Balbina, and Matthias Lewy. 2018. Theodor Koch-Grünberg's Living Musical Archive and the “Sharing Knowledge” Project. Reflections about an Engaged Ethnomusicological Project. in *V Jornada de Etnomusicologia e III Colóquio Amazônico de Etnomusicologia*. Belém: Universidade Federal do Pará.
- Lewy, Matthias. 2015. Objekte hören? Klang im ethnologischen Museum. Ein Beitrag zur angewandten auditiven Anthropologie. *Quo vadis, Völkerkundemuseum? Aktuelle Debatten zu ethnologischen Sammlungen in Museen und Universitäten*. Edited by K. Noack and M. Kraus. Bielefeld: transcript, 297–320.
- Lewy, Matthias. 2017. About Indigenous Perspectivism, Indigenous Sonorism and the Audible Stance. Approach to a Symmetrical Auditory Anthropology [Sobre el perspectivismo y el sonorismo

- indígenas, y la posición de escucha. Aproximación a una antropología auditiva simétrica]. *El Oído Pensante*, 5(2): 1-22.
- Lewy, Matthias. 2018a. Singing with Things in Ethnographic Museum's Archives: The Reunification of Material/Immaterial Units as Part of an Engaged Ethnomusicology. *Música em Contexto*, 12(1): 34–47.
- Lewy, Matthias. 2018b. Klangnarrative im ethnologischen Museum, *Musikausstellungen: Intention, Realisierung, Interpretation. Ein interdisziplinäres Symposium.*, 19. Edited by A. Meyer. Hildesheim: Georg Olms, 275–307.
- Lewy, Matthias. 2020. *Eröffnungsansprache zur Ausstellungseröffnung „KALKUTTA SCHWARZWEISS. Träume, Stimmen, Bilder“ (Schütz / Kaiser), 2 April, 2020.* Völkerkunde Museum Zürich. Unpubl. Ms.
- Said, Edward W. 1978. *Orientalism*. London: Routledge & Kegan Paul.
- Seeger, Anthony. 2017. Amazonie. Contes Sonores/Amazonia. Sound Stories/Amazonien. Klanggeschichten. *Yearbook for Traditional Music*, 49: 181–82.
- Simon, Artur. 2000. *Das Berliner Phonogramm-Archiv 1900-2000. Sammlungen der traditionellen Musik. The Berlin Phonogramm-Archiv 1900-2000. Collections of Traditional Music of the World.* Berlin: VWB - Verlag für Wissenschaft und Bildung.

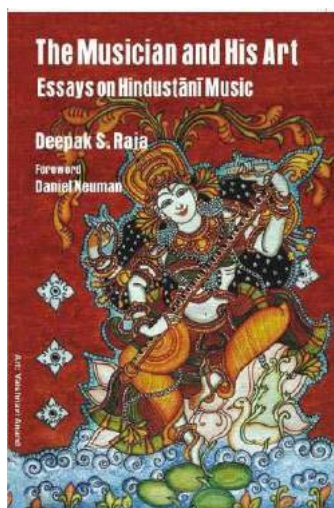

REVIEW OF
**THE MUSICIAN AND HIS ART: ESSAYS
ON HINDUSTĀNĪ MUSIC**
BY DEEPAK S. RAJA WITH A FOREWORD
BY DANIEL NEUMAN. NEW DELHI:
D.K. PRINT WORLD
[ISBN 10: 8124609551/ISBN 13: 9788124609552].

Gisa Jähnichen

Shanghai Conservatory of Music, contact: gisajaehnichen@web.de

Abstract

This is the Review of “The Musician and His Art: Essays on Hindustānī Music by Deepak S. Raja with a Foreword by Daniel Neuman, New Delhi: D.K. Print World.” This review was initiated through a request made by the author, which I was glad to accept.

Keywords

Hindustānī music, aesthetics, audiences, music philosophy, decolonizing academia

Deepak Raja’s book is a very brave try to overcome the recent demands of writing in the scheme of Euro-American thesis rigorism. The world of knowledge, as it seems, might feel comforted through a widely admitted subjectivity, the rare referencing¹, the unstructured implants of philosophical needles throughout the various chapters, and the freshness of personal opinions about any subject that crosses the way of Deepak Raja’s ideas.

Yet, a missing scheme, as one can easily find out, is not limited to the writing style. It is also often absent in the entire development of thoughts about the topic.

The different chapters are lectures and speeches that touch Hindustānī music in a rather specified way. Each of them is dedicated to a part of the whole, and, at the same time, wants to embrace the complete background. This lecture-approach can undoubtedly lead to creative inconsequentiality with some points to ponder upon but no definite ambition. Thinking to the varying audiences of those lectures, a visible structure might have helped draw attention and inspire holistic views. In some cases, an entire paragraph consists of dense ideas on music in general, thus reaching far beyond the meaning of Hindustānī music. I deny calling them simply ‘essays’. Those imparted philosophical outbreaks deserve an analytical sense and re-reading from different perspectives.

One of these contributions (lecture 7, page 66-77) is dealing with philosophy of music when pondering upon the meaning of “abstraction”. It is rather a provocation of general thoughts on any type of music. The author asks among others “How much can you dilute the contemplative genres and movements before you are obliged to call it entertainment?” (page 71). This question

¹ For example, the author mentioned a number of textbooks circulating in academic institutions without giving any reference (page 104). This seems to be to avoid pinpointing single issues and rather to give space for a general discussion.

tells a lot about the author who obviously sees entertainment as something “diluted”, less artful, generally something less. Also, the author might have switched off his generally sharp observation of historical differences when mentioning “contemplative genres” as if musical expressions can be divided into general genres, which possibly were all the time entertaining to some audiences². In another lecture, very dense of information, he takes his time to explore “The Hindustānī music tradition is so designed that, knowingly or unknowingly, every significant musician is a product of his generation, speaks on behalf of his generation and addresses primarily his own generation of listeners” (page 152). This could probably apply to any type of music in the world, regardless of what academic writing offers so far. The main question to discuss will be whether this book on Hindustānī music is yet another book on the aesthetics of performing arts in general or is it indeed dedicated to specific problems of Hindustānī music. In order to support an extended discussion, the space and time limitations of terms used are kept open and widely untouched by the author. This situation invites critical thinking and does not follow an authoritative approach.

Deepak Raja’s 6th lecture on Amplification, Recordings, and Hindustānī Music (page 47-65) given as the Bhatkhande Memorial Lecture, Dadar-Matunga Cultural Centre, Mumbai, 22 October 2016, is a fine example of the mixture of personal opinions, detailed knowledge of social facts, and the unawareness or purposeful avoidance of already existing references in this regard such as the details provided by Gronow (1981), Gronow and Saunio (1998), or by Kinnear (1994).

Another very interesting lecture is scrutinizing the role of music criticism. The main topic seems quite far away from here and plays only a role as an example the author is familiar with. Interestingly, the outcome is somewhat contradictory with regard to exactly what the author is doing through this book: Throwing a critical light on the development of Hindustānī music and the understanding among musicians and audiences. The last three paragraphs of this lecture are written with a warning undertone such as “Critical output emerging in an environment dominated by Western scholarship may win academic laurels and acquire an international following amongst Hindustānī music enthusiasts. If Indian scholarship cannot establish a meaningful dialogue with the performing tradition, both the traditions will soon be heading for sterility”. Reviewing this short paragraph reveals many points of static categories, that are questioned in other places of the book. ‘Western’ and ‘scholarship’ alone are two terms that need not only a better embedding and differentiation, but also a better understanding as a historical and demographic process. The same may apply to terms such as ‘tradition’ and ‘international’. Again, the author opens up to a wide field of discussion that hopefully follow.

All his lectures on specific details in Hindustānī music add to the welcoming discussions and deliver an excellent summary into the most current views on various issues within its world at the beginning of the 21st century.

Finally, I recommend the book all those people who want to look through the gaze of Hindustānī music on the world of sound as art, as a product within a national or the twisted world market, or as something that transforms aesthetic symbols into subjective communication.

The author understood to keep his statements clear enough, for example through adopting the rule of three in a row, and straight forward in order to avoid being misinterpreted. The book is also recommended to those readers who may have another view on the same issues. I think that a continuous discussion is entirely in line with the goal of the author’s efforts.

² Stimulatingly described by Meddegoda and Dias (2012).

REFERENCES

- Gronow, Pekka and Ilpo Saunio. 1998. *International History of the Recording Industry*. London: Continuum.
- Kinnear, Michael. 1994. *The Gramophone Industry's First Indian Recordings 1899-1908*. Bombay: Popular Prakashan.
- Gronow, Pekka. 1981. The Recording Industry Comes to the Orient. *Ethnomusicology*, 25 (2): 251-284.
- Meddegoda, Chinthaka and Ruwin Dias. 2012. Interaction of Musicians and Audience during Performances of Hindustānī Classical Music. *Music and Dance in Environment*. UPM Book Series on Music Research, vol. 5. Edited by Gisa Jähnichen and Chinthaka Meddegoda. Serdang: UPM Press, 83–94.

REVIEW ABOUT THE CURRENT SITUATION OF H'RÊ PEOPLE'S MUSIC AT DIFFERENT LOCATIONS IN QUẢNG NGÃI PROVINCE, VIETNAM

Nguyễn Thế Truyền

Culture and Arts Magazine (Ministry of Culture, Sports and Tourism of Vietnam),
Visiting lecturer at HCMC Conservatory of Music,
contact: thetryenvhnt@gmail.com

Abstract

Segmenting H'rê music regions in the mountains of Quảng Ngãi is very difficult. In reality, the differences in music practices between the H'rê people and the H'rê regional dialects are unclear, as well as the problem of cross-cultural relationships in music taking place with neighboring ethnic groups. However, some scholarly approaches (Tô Ngọc Thanh, 1995; Lê Huy and Minh Hiến, 1994) still boldly segment the H'rê music with the desire to provide some scientific information about a cultural phenomenon of the H'rê people in a specific location. The article divides H'rê music practices in Quảng Ngãi into two relatively different regions: the center region and the suburban region. In particular, the center region includes the districts of Sơn Hà, Ba Tơ and Minh Long; The suburban region includes places that preserve, promote, reconcile music practices that are at risk of disappearance. In addition, the article also highlights the different elements of H'rê music practices in different regions of Quảng Ngãi province.

Keywords

H'rê music, Gongs of H'rê, Musical dialects, Quảng Ngãi province

INTRODUCTION

The H'rê people speak a language that is part of the Môn - Khmer language group and the South Asian language family, living mainly in the mountainous regions of Quảng Ngãi province, with the 19th largest population out of 54 ethnic groups in Vietnam. They also have other names: Mọi¹ Đá Vách, Mọi Sơn Phòng, Thượng Ba Tơ, Mọi Lũy, Chom, Chăm Rê, Chăm Quảng Ngãi, and others (...). In Quảng Ngãi, the number of H'rê ethnic people live along the H'rê River is more crowded than in other places. The article contributes to the study and comparison of H'rê music values in different regions within Quảng Ngãi province.

Currently, the writing style of this ethnic group's name is not yet unified: H'rê, Hre, Hrê, Hore, Horê. It is agreed upon to adopt the term with which the H'rê call themselves "H'rê". This is the name associated with the name of a river in their supposed homeland (H'rê river), which would probably be more exactly understood.

LITERATURE ON H'RÊ MUSIC PRACTICES

Some documents mention music practices of the H'rê ethnic group such as "*Vietnamese traditional instruments*" by Lê Huy and Minh Hiến, World Publishing House, Hanoi - 1994.

¹ "Mọi" comes with the meaning of "the wilds".

Due to the wide scope of the study, some of the H'rê instruments were not mentioned in sections.

“Introduction of Vietnamese Ethnic Musical Instruments” by Tô Ngọc Thanh (1995), consists of some examples of the H'rê people.

A journal article under the title *“H'rê Folk Music”* by Thế Truyền (2000), and one under the title *“Folk Music and Dance of the Cadong, Co, H'rê Ethnic People in Quảng Ngãi Province”* by Lê Toàn (2001) show some more evidence. In these documents, Thế Truyền and Lê Toàn dedicated a larger part to the topic. The folk songs and instruments of this ethnic group have been mentioned in later field work reports of the author about *“H'rê Folk Music”* that are based on long term observations in ethnic minority regions of western Quảng Ngãi from the year 2000 to 2001. The reports were followed by *“Instruments of the H'rê ethnic group in Quảng Ngãi”* by Nguyễn Thế Truyền (2010). This book is a fairly completed and detailed monograph about H'rê musical instruments. However, H'rê folk music in different regions of Quảng Ngãi province is not mentioned in this document.

METHODS OF RESEARCH

This paper used methods of music research, sociology, field surveys in specific communities of musicians (P'lây² H'rê), as well as methods of synthesizing, analyzing materials and documents.

Through doing fieldwork, it is very difficult and not feasible to divide H'rê music in the Quảng Ngãi mountainous region into different groups. Due to the fact that the differences in music between several H'rê regions are not clear, as well as the problem of cross-cultural events in practicing music which are taking place among neighboring groups of people.

However, academically, H'rê music can be further segmented with the goal to provide some more detailed information about music practices of the H'rê people in a specific location.

CENTRAL REGION AND SUBURBS

H'rê music practices in Quảng Ngãi can be divided into two relatively different regions, temporarily called: center (crowded) region and suburbs.

CENTRAL REGION

Based on the H'rê population density in Quảng Ngãi province, the densely populated region includes districts of Sơn Hà, Ba Tơ and Minh Long.

² “P'lây” = group of musicians that know each other, friends, family members, the meaning of coming from the same hamlet.



FIGURE 1: Map of Population distribution (ethnic minorities in Quảng Ngãi). (Source by courtesy of Office for Culture and Information. 1996).

SƠN HÀ

Most of H'rê instrumental music and songs are found in this region. Traditional practices include: calêu (love songs), kachôi (autobiographic songs), t'jeo (worship songs), taoi (lamenting); musical instruments used include: *chinh* (3 units), *tàlía*, *akhung*, *pênhpút*, *amó*, *rangói*, *rôđoang*, *b'rooc*, *k'râu*, and others. This information could be collected over a longer period of time by the author.



FIGURE 2: *Rangói* (canister-left, *rangói*-right); Figure 3: The stacking set of *chinh* with 3 units; Figure 4: *Amó* and canister for preservation of H'rê people (photos by the author).

BA TƠ

Here, the Ba Thành commune is chosen (Ba Thành commune has 4 hamlets: Teng Village, Trường An, Huy Ba 1, Huy Ba 2) to focus on. This commune is about 10 km far from the district's center, to the South. Here, is the capital of H'rê culture, and this includes music

practices. There are a number of H'rê artists well-known among the country's majority such as Đinh Thị B'ớt, Đinh Văn Ước, Đinh Thị Nứa, Phạm Văn Cường, Phạm Văn Nin, and others. One can see the prominence of the *túc chình* (playing the *chình*) and a number of folk music genres such as *talêu*, *kachôi* that no other H'rê region can provide.



FIGURE 5: Artist Đinh Thị B'ớt (photo by the author).



FIGURE 6: Artist Đinh Văn Ước making instruments (photo by the author); FIGURE 7: Instruments made by artist Đinh Văn Ước (photo by the author).



FIGURE 8: H'rê people's *chinh k'la* (photo by the author).

MINH LONG MUSIC REGION

In the middle of Minh Long, there is the Long Mai community, which lives very close to the district centre. As in Ba Thành (or Ba Tơ), people at this place may try to represent the music of the Minh Long region. There are found H'rê musical assets that are not easily to find in other regions, such as singing during worshipping *Cham Voray*, or singing *Dam Hoa*. The H'rê people in the "Rvá" are very passionate about their *pênhpút* (made from two neohouzeaua, a specific type of bamboo).



FIGURE 9: H'rê people's set of *chinh* (photo by the author).

SUBURBS

For a long time, in folklore studies (i.e. Nguyen Trac Di, 1972) was often talked about that this zone is the peripheral region of died out habits. However, in reality, the music survey of the H'rê people in Quảng Ngãi did not entirely result in confirmation. There are suburban regions to store and promote cultural activities. The suburbs of the music practices and the suburbs in general are seemingly in danger of disappearing.

There is the Sơn Thượng community, which is in the suburban region of Sơn Hà. Although called suburban, the resources of music practicing among the H'rê in Sơn Thượng are quite intense. In Tà Pa hamlet, there are very talented singers and performers, such as Đinh Ngọc Su, Y Véc, Đinh Văn Dát, and others.

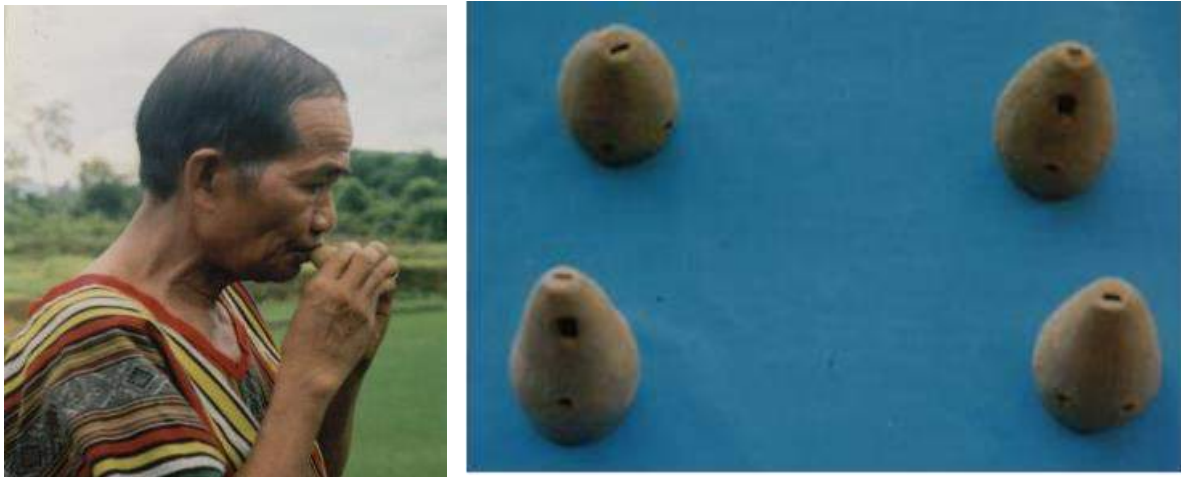

FIGURE 10: Artist Đinh Ngọc Su playing *tàvố*; Figure 11: *Tàvố* made of soil (photos by the author).



FIGURE 12: H'rê people's *akhung* (photo by the author).

Especially, artist Đinh Ngọc Su, who knows a lot about customs and habits as well as about H'rê music, can reproduce many folk songs and music by heart, as well as creates and performs almost all kinds of musical instruments. Being recorded and introduced widely within the country artist Đinh Ngọc Su and has been recognized as one of the "Folk Artists" by the Vietnam Folk Arts Association.

The suburb of Mang Cà Muồng hamlet, Sơn Bao commune, Sơn Hà district has a very special position adjacent to the residence of Xơ Đăng people (Cadong group) in Sơn Tây district and Co people in Tây Trà. According to artist Đinh Văn Ca, most of the Xơ Đăng people in the hamlet identify themselves as H'rê people. Music activities in the hamlet are mainly gongs. Besides using *chinh* (3 units), the H'rê and Xơ Đăng people play gong sets, each with 2 to 7 or even 10 single gongs.



Figure 13: The set of *ching* with 7 units + 1 drum; Figure 14: The set of *ching* with 10 units + 1 drum (photos by the author).

Also, there are some suburbs such as X'râu hamlet. The Ba Nam (Ba Tơ) community is located adjacent to the residence of Ba Na (Kriêm group) in two communities called An Toàn and An Nghĩa, situated in An Lão district, Bình Định province. Here, in addition to the traditional 3 units *ching*, the H're people also performed the five units *ching* along with a dance team made of girls in beautiful embellished costumes.



FIGURE 15: *Ching* dance team at X'râu hamlet, Ba Nam commune; Figure 16: 5 units *ching* team at X'râu hamlet, Ba Nam commune (photos by the author).

In the suburban region of Trà Tân commune (Trà Bông, Quảng Ngãi), there are four hamlets: Tà Ót, Tà Ngon, Trường Biện and Trường Giang. In particular, Trường Giang hamlet (local people called p'lây H'rê) is a H'rê hamlet. Trà Bông is a mountainous district adjacent to Sơn Hà district, where many Co people reside already for a long time. Through our surveys and investigations, the current situation appears as follows:

An exchange of cultural activities, especially for the Co, did not take place. It can be explained by the cultural coagulation, the complexity of having to live separately, or because of individual group pride. According to the author's observation, the cultural exchange does not take place between the H'rê and the Co in P'lây H'rê due to all of these reasons.

According to the elderly artist Đinh Thị Sa (born in 1939), P'ây H'rê has not been a place of cultural activities such as requested by earlier visitors for a long time. Therefore, nobody owns any *chinh*. Elders are unable to sing *kachôi* and only know a few *talêu* songs³, but it is difficult for them to remember the text and melody. This strange phenomenon possibly shows that there has been a cultural disruption which must have happened to them and the H'rê community here.

The suburban region in Trường Lệ hamlet, Hành Tín Đông commune, Nghĩa Hành district (Kinh people district), in the midland region of Quảng Ngãi, adjacent to Minh Long district⁴. In particular, Trường Lệ hamlet has H'rê people who have lived there for many generations, but the population is very sparse. Their current state of music practices is alarmingly at the risk of loss. According to the old artists Phạm Thị Hè (born in 1933) and Phạm Thị Bum (born in 1945), the H'rê people here only have a few *chinh*s, only used for art festivals, the rest of the time is almost forgotten.

In general, in these suburbs, H'rê music has faded a lot compared to the middle regions. Many elderly people and young people in the suburbs sang revolutionary songs (during the first and second Indochina War); some folk songs in the Central Highlands are quite popular: "Celebrating new rice", "Sanitary chopsticks", "Ơi anh ơi"⁵; The song "Nhay sạp" and "Chap pa flower" are absorbed by the Kinh people; some of the songs follow the boléro scheme as propagated by the Saigon regime (before April 30, 1975); some famous French songs have been translated as well. The local songs and instruments only exist through the memory of a few elders.

DIFFERENCES BETWEEN MUSIC REGIONS

Some of the different factors between H'rê music regions in Quảng Ngãi, are: some different names, strengths of music regions, and some different songs.

The names of H'rê folk songs and instruments differ in the named regions. In Ba Tơ, Minh Long, the genre of love songs is called *talêu*, and in Sơn Hà, that genre is called *calêu*. While in Sơn Hà the music instrument is called "*vàpút*", in Minh Long it is called the "*pênhpút*".

Regarding the strengths of the music regions, it can be seen that each H'rê region in Quảng Ngãi has its own strengths. While the strengths of the Sơn Hà region are the use of *b'rooc*, *pênhpút*, *akhung*, *tàvố*, and *rođoang*, the strengths of the Ba Tơ region are *chinh* (three units), *chinh k'la* (made from bamboo) and other types of local songs like *talêu* and *kachôi*. The H'rê in the Ba Tơ region along the Liên river have a very good tradition of *túc chinh*, but not the habit of using other instruments. Many valuable patterns of *túc chinh* were kept in this region, such as those of Phạm Văn Cường⁶.

The strength of the Minh Long region is the *pênhpút* and the *t'jeo* genre⁷.

There are instruments that are present in one region but not in others. Like *akhung* and *tàvố* in Sơn Hà, which cannot be found in Minh Long and Ba Tơ. Another example is *pênhpút* consisting of two pipes in Minh Long, which cannot be found in the Sơn Hà region - although for H'rê people, these instruments are easy to make. There are differences between the three -

³ Local people call it "calêu" – similar to the people in the central region.

⁴ There are seven hamlets: Thiên Xuân, Nguyễn Hòa, Đồng Giữa, Nhơn Lộc 1, Nhơn Lộc 2, Khánh Giang, Trường Lệ.

⁵ Which possibly belongs to Ba Na.

⁶ Secretary of Ba Thành Commune Party Committee.

⁷ Singing during worshipping.

túc *chinh* set scales in the region. For example, the scales in the Ba Tơ region is different from that in Minh Long as follows:

The pitch in the scales in Ba Nam and Ba Tơ:

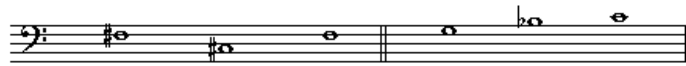

While the pitch in the three-túc *chinh* set scales of Long Mai commune is different as following:

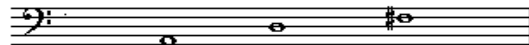

FIGURE 16: Reserchers and Prof. Tamura Fumi at H'rê region (Photo by courtesy of Tamura Fumi).

FINAL THOUGHTS

Regarding H'rê music in Quảng Ngãi province, there are different regions, which are the central region and the suburbs. They consist of varied features regarding their music practices and their knowledge about traditions. This can open up many different research directions, not only for music studies but also for a number of other social sciences such as cultural anthropology and history. These studies may allow for first insights as a point of departure and can then step by step analyse a suggested relatedness of these differences.

REFERENCES

- Haguet, H. 1905. *Noitice ethnique sur les Moi de la région de Quảng Ngãi* (Ethnographic record of Moi people of Quảng Ngãi area), *Revue Indochinoise*.
- Maitre H. 1912 *Les jungles Moi*. Paris: unknown publisher.
- Nguyen Trac Di. 1972. *Ethnic Minorities of Vietnam (Origins and Customs)*. Saigon: Ministry of Ethnic Minority Development.
- Ta Hien Minh, ed. 1996. *Cultural Life of Ethnic Minorities in Quảng Ngãi*. Office for Culture and Information.
- Le Huy and Minh Hien. 1994. *Vietnam's Traditional Instruments*. Hanoi: World Publishing House.
- Le Toan, 2001, Cadong, Co, H'rê Folk Music and Dance in Quảng Ngãi Province. *Academic Bulletin* 5. Hanoi: Vietnamese Music Institute, 32-62.
- Nguyễn Thế Truyền. 2000. H'rê Folk Music. *Journal of Culture and Arts* (December issue): n.p.
- Quảng Ngãi Statistical Office, "Statistical Yearbook 2006", Quảng Ngãi, 2007, 15.
- Many authors. 2004. *Tây Nguyên gong culture region*, Institute of Culture and Information, Hanoi, 361-377.
- Nguyễn Thế Truyền. 2003. *Interview with Đinh Ngọc Su and Đinh Văn Ước*. Quảng Ngãi.
- Lê Huy and Minh Hiến, eds. 1994. *Vietnamese Traditional Instruments*. Hà Nội: World Publishing House.
- Tô Ngọc Thanh. 1995. *Introduction of Vietnamese Ethnic Musical Instruments*. Ho Chi Minh City: Arts Publishing House.
- Thế Truyền. 2000. *H'rê Folk Music*. Hà Nội: *Journal of Culture and Arts*. Entire December number
- Lê Toàn. 2001. *Folk Music and Dance of the Cadong, Co, H'rê Ethnic People in Quảng Ngãi Province*. Hà Nội: Announcement No. 5, Music
- Nguyễn Thế Truyền. 2010. *Instruments of the H'rê ethnic group in Quảng Ngãi*. Hà Nội: Vietnam Folk Arts Association, Culture and Information Publishing House.

AEMR

Asian-European Music Research Journal is a double-blind peer-reviewed academic journal that publishes scholarship on traditional and popular musics and field work research, and on recent issues and debates in Asian and European communities. The journal places a specific emphasis on interconnectivity in time and space between Asian and European cultures, as well as within Asia and Europe.

The *Asia-Europe Music Research Center at the Shanghai Conservatory of Music (AEMRC)*, which is the physical *site of the journal*, is a new academic platform established by the conservatory on the basis of synergetic cooperation between academic institutes at home and internationally. The platform focuses on the study of musical cultures in the geographical arenas connecting Asia with Europe, specifically looking at the flows of musical ecologies and civilizations. It examines and compares the histories and current developments of multicultural practices between Asia and Europe, and explores the reinterpretation of traditional music resources in applied and sustainable contexts. The Centre seeks to promote in-depth academic exchange at home and abroad, with emphasis on interdisciplinary and cross-disciplinary collaborations, including the promotion of cultural diversity in the digital humanities and musical knowledge building. It aims at providing a supportive research and teaching environment with a commitment to the larger interests of equality, tolerance, capacity building and the stimulation of artistic creativity, and the exploration of innovative approaches towards redefining fields of cultural study.

The journal is also associated with longstanding ‘key tertiary research bases’ focusing on humanities and the social sciences in Shanghai, including the Chinese Ritual Music Research Center and the Oriental Musical Instruments Museum, both at Shanghai Conservatory, as well as with the work of other departments at the Conservatory. The Center also cooperates with various Chinese and international universities and research institutions.

EDITORIAL BOARD

Editor: Xiao Mei, Shanghai Conservatory of Music, e_xiaomei@126.com / editor@asian-european-music-research-ej.com

Reviews Editors: Tan Hwee San, SOAS, ht5@soas.ac.uk and
Chuen-Fung Wong, Macalester College, wong@macalester.com

Send books, films, links and other materials for review to:

Tan Hwee San, Chuen-Fung Wong, Gisa Jähnichen, Xiao Mei

Co-Editor: Gisa Jähnichen, Shanghai Conservatory of Music, gisajaehnichen@web.de / editor@asian-european-music-research-ej.com

The official email address of AEMR-EJ is AEMRC@shcmusic.edu.cn

Editorial Board:

- Ako Mashino (Dr., Tokyo University of the Arts, Japan) akomas@sky.email.ne.jp
- Alexander Djumaev (Dr., Union of Composers of Uzbekistan) adjumaev@yahoo.com
- Chinthaka P. Meddegoda (Dr., UVPA, Colombo, Sri Lanka) chinthaka.pm@vpa.ac.lk
- Chow Ow Wei (Dr., Putra University, Malaysia) chowwei@upm.edu.my
- Earl Jimenez (Dr., Philippine Women’s University, Philippines) ecljimenez@pwu.edu.ph
- Esbjörn Wettermark (Dr., Office for Cultural Development Gävleborg, Sweden) esbjorn.wettermark@regiongavleborg.se
- Helen Rees (Prof. Dr., UCLA, USA) hrees@ucla.edu
- Liu Hong (Dr., Shanghai Conservatory of Music, China) liuhongusa@163.com
- Xu Xin (Dr., Shanghai Conservatory of Music, China) iamxuxin@yeah.net
- Razia Sultanova (Dr., Cambridge University, UK) razia@raziasultanova.co.uk
- Tan Shzr Ee (Dr., Royal Holloway, University of London, UK) shzree.tan@rhul.ac.uk

CALL FOR SUBMISSIONS

The journal provides a forum to explore the impacts of post-colonial and globalizing movements and processes on these musics, the musicians involved, sound-producing industries, and resulting developments in today's music practices. It adopts an open-minded perspective on diverse musics and musical knowledge cultures.

Despite focusing on traditional and popular musics, relevant themes and issues can include explorations of recent ideas and perspectives from ethnomusicology, social and cultural anthropology, musicology, communication studies, media and cultural studies, geography, art and museum studies, and other fields with a scholarly focus on Asian and European interconnectivity. The journal also features special, guest-edited issues that bring together contributions under a unifying theme or specific geographical area.

In addition, the journal includes reviews of relevant books, special issues, magazines, CDs, websites, DVDs, online music releases, exhibitions, artwork, radio programs and music festivals.

The official email address of the Center is AEMRC@shcmusic.edu.cn.

Please, send your full submissions (non-formatted with all your figures and items placed within the text of a word-document and a cover sheet with your personal data) to this email address. The editors will then get in touch with you on an individual basis.

ABSTRACTING & INDEXING

RILM (core), others in progress

FREQUENCY AND PUBLICATION

Two issues per volume year, June (summer) and December (winter) commencing 2018.

EDITORIAL REMARK

Instead of providing full biodata of the authors, we leave this decision to the readers (starting with number 4) who can contact the authors directly via email.

CODE OF ETHICS

PUBLICATION ETHICS AND MALPRACTICE STATEMENT FOR AEMR-EJ

1. PUBLICATION, AUTHORSHIP AND AUTHOR'S RESPONSIBILITIES

AEMR-EJ is a double-blind, peer-reviewed journal. Papers in whatever research tradition must report new scientific findings. They should knowledgeably present the findings, give correct and complete references to previous related work by the authors and by others (citations), repeat previously published findings only inasmuch as it is necessary for understanding the context, and in a clearly identified form.

Authors of scientific publications are always jointly responsible for their content. A so-called "honorary authorship" is inadmissible.

With this definition of authorship, other contributions, even though seemingly significant are not by themselves regarded sufficient to justify authorship. For example, the following are not grounds to claim authorship:

- the responsibility for obtaining the funds for the research,
- the contribution of important materials,
- the training of co-authors in certain methods,
- involvement in the collection and assembly of data,
- directing an institution or working unit in which the publication originates.

However, institutions, organisations, or private persons funding or otherwise assisting the author's research have to be acknowledged in the text of the contribution.

Authors are obliged to participate in the peer-review process, to provide retractions or corrections of mistakes and to state that all data in article are real and authentic. In papers with multiple authors, all authors have to state that they have significantly contributed to the research.

Authors have to list all references used in the paper. This includes written and audiovisual sources. Plagiarism or any use of fraudulent data will lead to rejection from publication. In the process of editing, detection software is used to help identify such issues. With respect to the originality of papers published, it is strictly forbidden to publish the same paper in more than one journal or book series at a time.

By making a submission for consideration, the author(s) agree on all the statements above.

2. RESPONSIBILITY FOR THE REVIEWERS AND EDITORS

Reviewers and editors of submitted manuscripts are bound to respect confidentiality and to disclose conflicts of interest with respect to the research, the authors, and/or the research funders.

Judgments should be objective, constructive and based on best scientific practice. Reviewers should recommend relevant published work, including audiovisual materials, which are not cited.

Reviewers must agree to respond to a submitted manuscript within 6-8 weeks.

Editors have complete responsibility and authority to accept or reject an article, based on the recommendations of the reviewers. Editors should recommend a submission for publication, suggest that further revisions be made, or reject it outright. Editors must preserve the anonymity of reviewers. When a paper is accepted for publication, editors and reviewers must agree on the statements above.

3. PUBLISHING ETHICS ISSUES

The editorial board will monitor ethics of publication, following the rules and practices mentioned by COPE. [1] Papers submitted that cause ethical conflicts through plagiarism, fraudulent data, or issues that endanger the integrity of any academic record, will be rejected and the authors excluded from further publication in the series. Rejection of a paper follows the reviewers' recommendations and a majority decision by the editorial board. In the same way, the editorial board precludes business needs from compromising intellectual and ethical standards.

The editorial board will publish corrections, clarifications, retractions and apologies, if necessary. Authors and readers are invited to raise any ethical concerns with the board.

ASIAN-EUROPEAN MUSIC RESEARCH JOURNAL
Vol. 5 (Summer 2020)

Editor:

Xiao Mei, Shanghai Conservatory of Music

Reviews Editors:

Tan Hwee San, SOAS

Chuen-Fung Wong, Macalester College

Co-Editor:

Gisa Jahnichen, Shanghai Conservatory of Music

Editorial Board:

Ako Mashino, Tokyo University of the Arts

Alexander Djumaev, Union of Composers of Uzbekistan

Chinthaka P. Meddegoda UVPA

Chow Ow Wei, UPM

Earl Jimenez, Philippine Women's University

Esbjorn Wettermark, Office for Cultural Development Gavleborg

Helen Rees, UCLA

Liu Hong, Shanghai Conservatory of Music

Razia Sultanova, Cambridge University

Tan Shzr Ee, Royal Holloway, University of London

Xu Xin, Shanghai Conservatory of Music

Logos Verlag Berlin

ISSN 2625-378X